

Vertical Panel

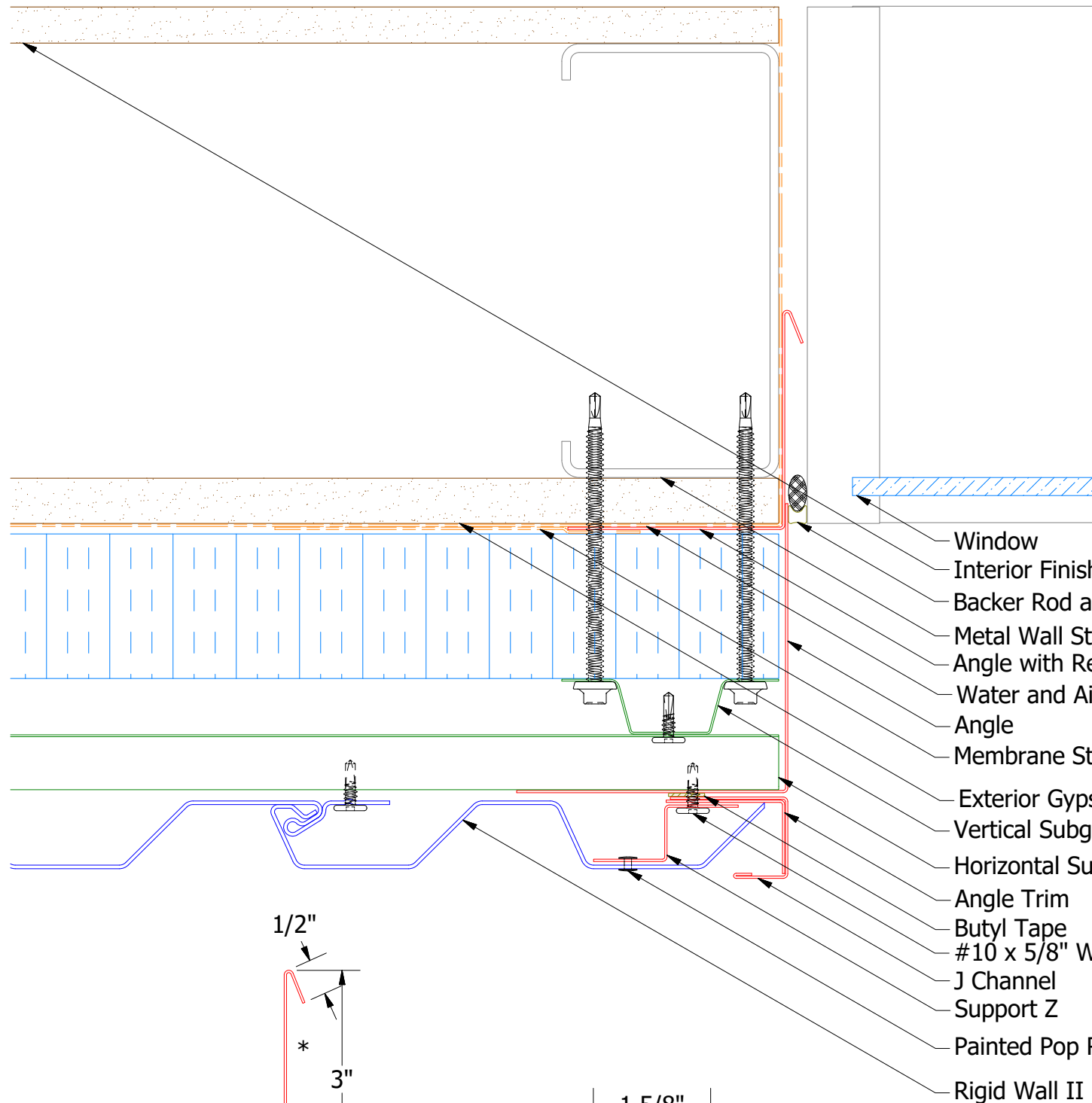

Alternate Subgirt Orientation (NTS)

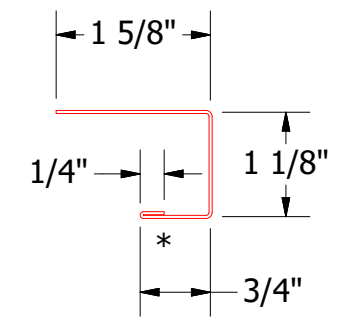
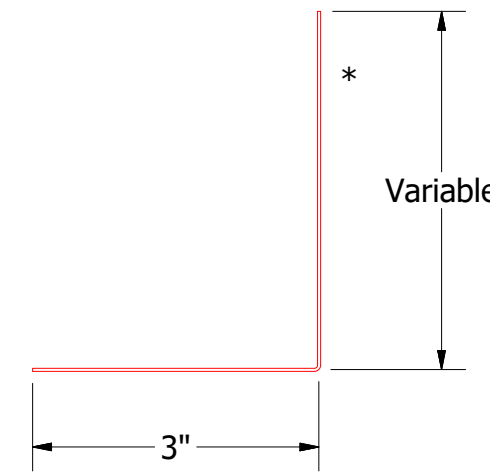
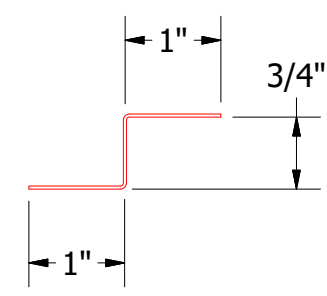
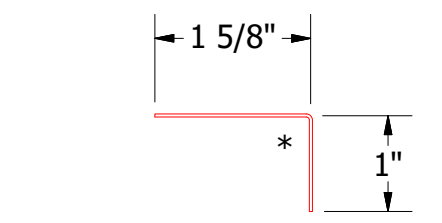
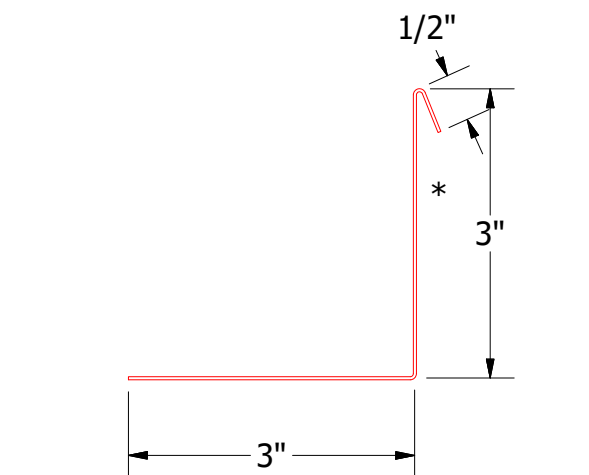
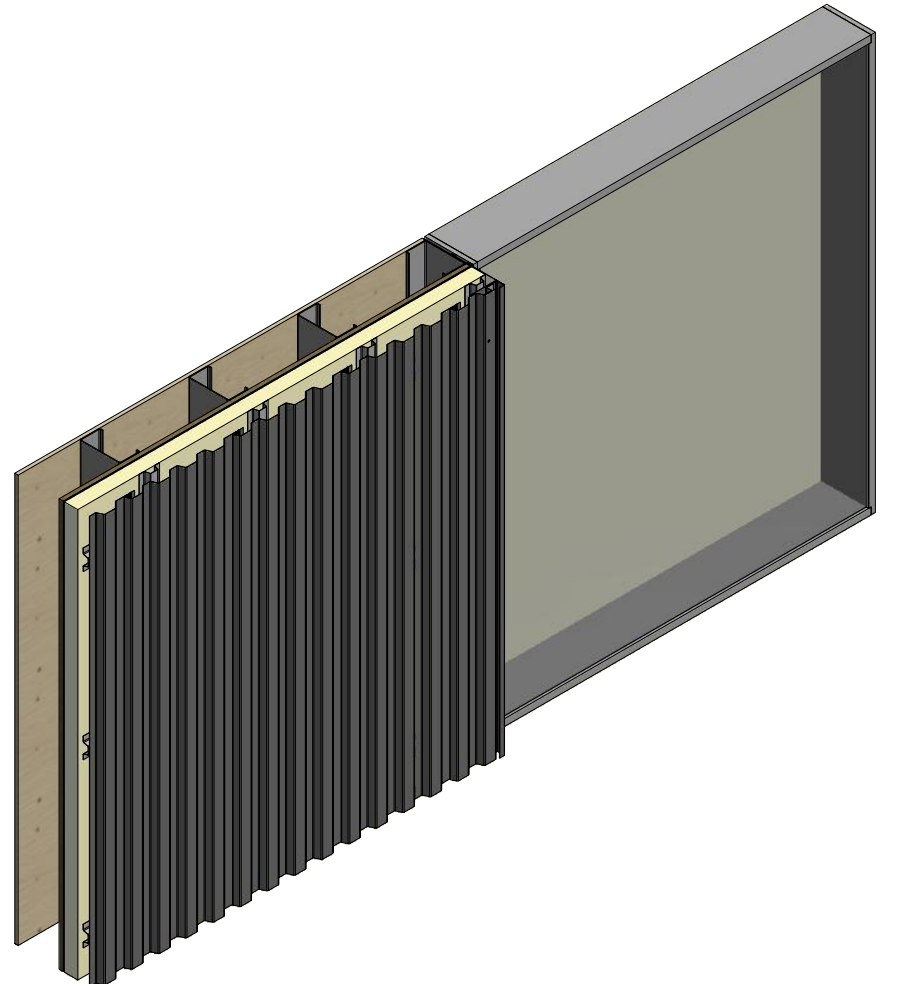
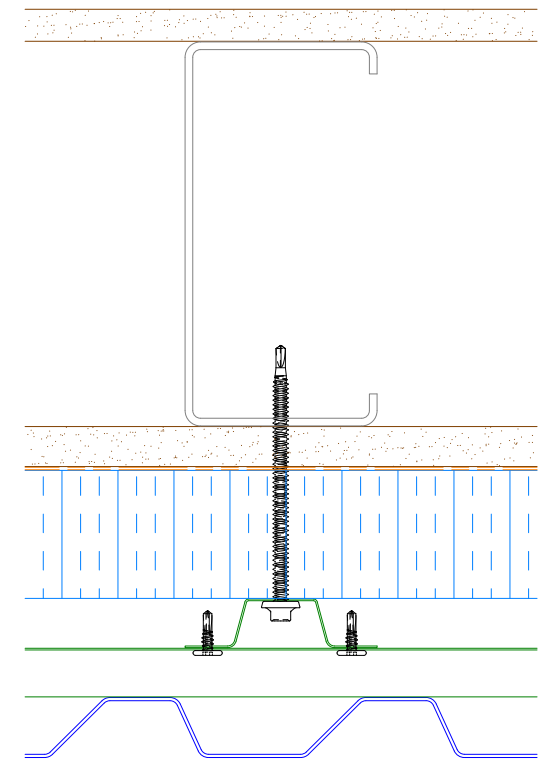

2 Stage Method of Weather Proofing

		ATAS INTERNATIONAL, INC Allentown PA 610-395-8445 Mesa AZ 480-558-7210	
TITLE Rigid Wall II Jamb Detail			
DWG. NO.	DR	KRK	DATE
	APP		DATE
MATERIAL		SH. SIZE	B
		SCALE	X:X

REV. NO.	DATE	DESCRIPTION OF REVISION	BY	APP