

# Vertical Panel

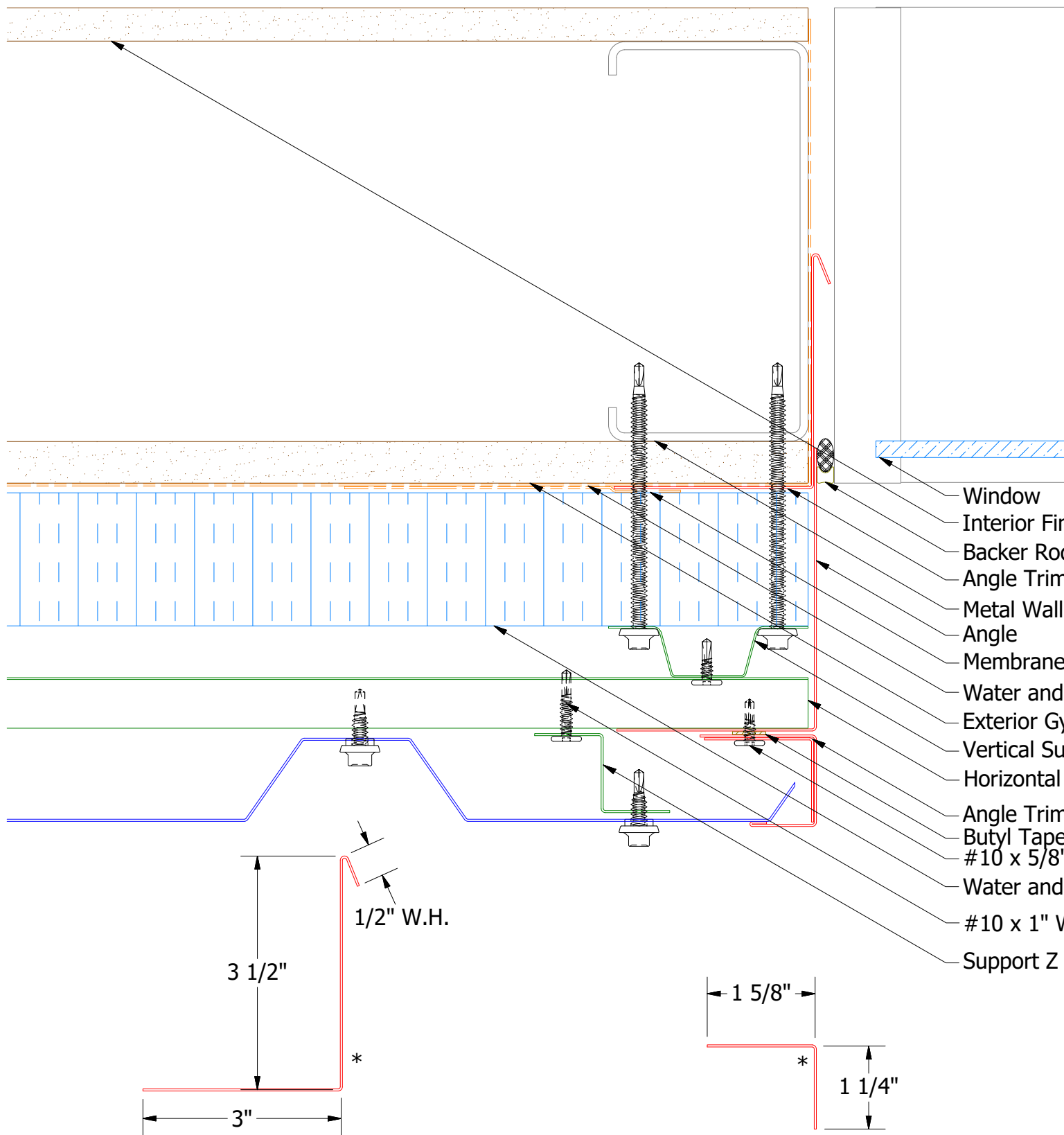

## Alternate Subgirt Orientation (NTS)

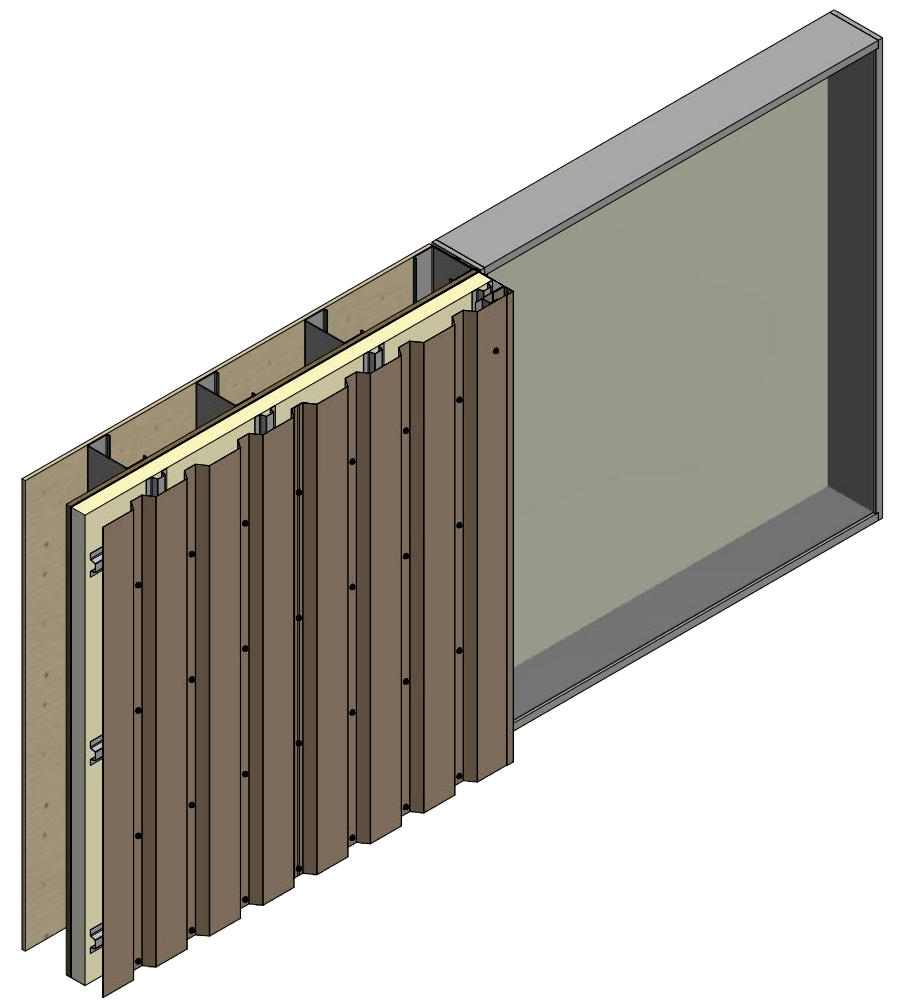
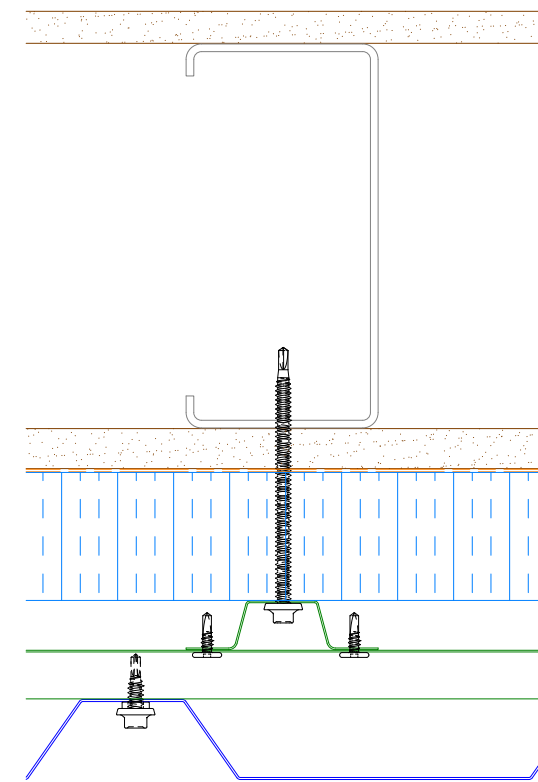

- Window
- Interior Finish
- Backer Rod and Sealant
- Angle Trim with Return
- Metal Wall Stud
- Angle
- Membrane Strip over Angle Trim with Return
- Water and Air Resistive Barrier
- Exterior Gypsum Board
- Vertical Subgirt
- Horizontal Subgirt
- Angle Trim
- Butyl Tape
- #10 x 5/8" Wafer Head Fastener
- Water and Air Resistive Barrier
- #10 x 1" Wafer Head Fastener
- Support Z

BPA683-Angle Trim with Return

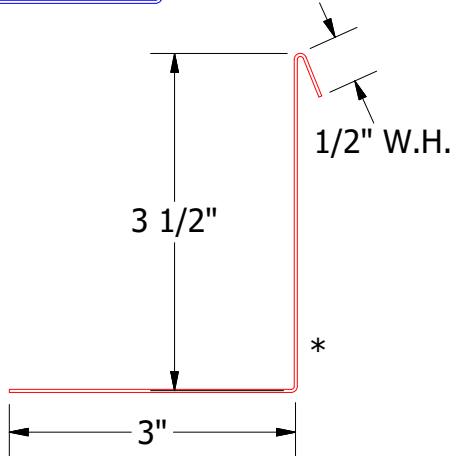

BPA280-Angle Trim

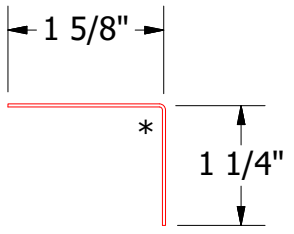

BPA681 - Support Z (if conditions apply)

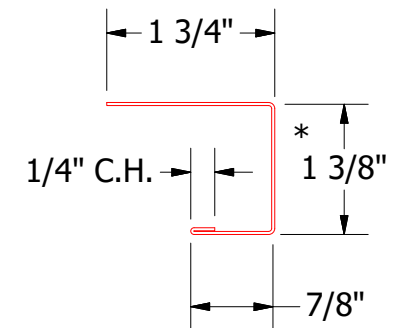
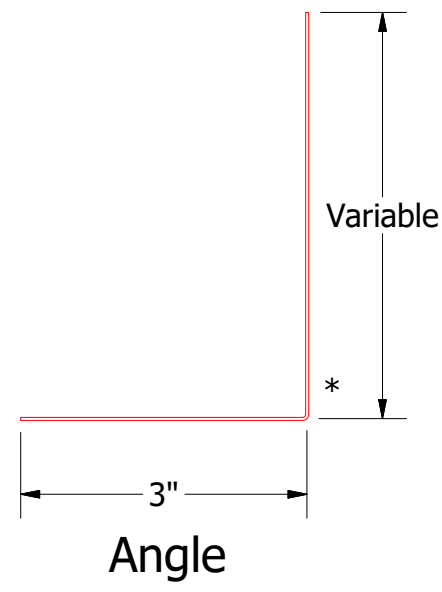
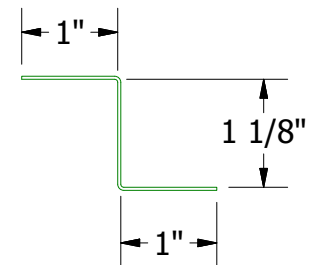

BPA138-J Channel

Note: \* denotes color side.

REV. NO.	DATE	DESCRIPTION OF REVISION	BY	APP	DR	DMR	DATE
1	4/16/2021	Added Support Z Trim and color side note.	DMR				4/20/2017

TITLE		PenumWall Open Jamb Detail					
DWG. NO.		DR	DMR	DATE	4/20/2017		
MATERIAL		APP		DATE			
SH. SIZE	B	SCALE	X:X				

**ATAS** ATAS INTERNATIONAL, INC  
 Allentown PA  
 610-395-8445  
 Mesa AZ  
 480-558-7210