

# Vertical Panel

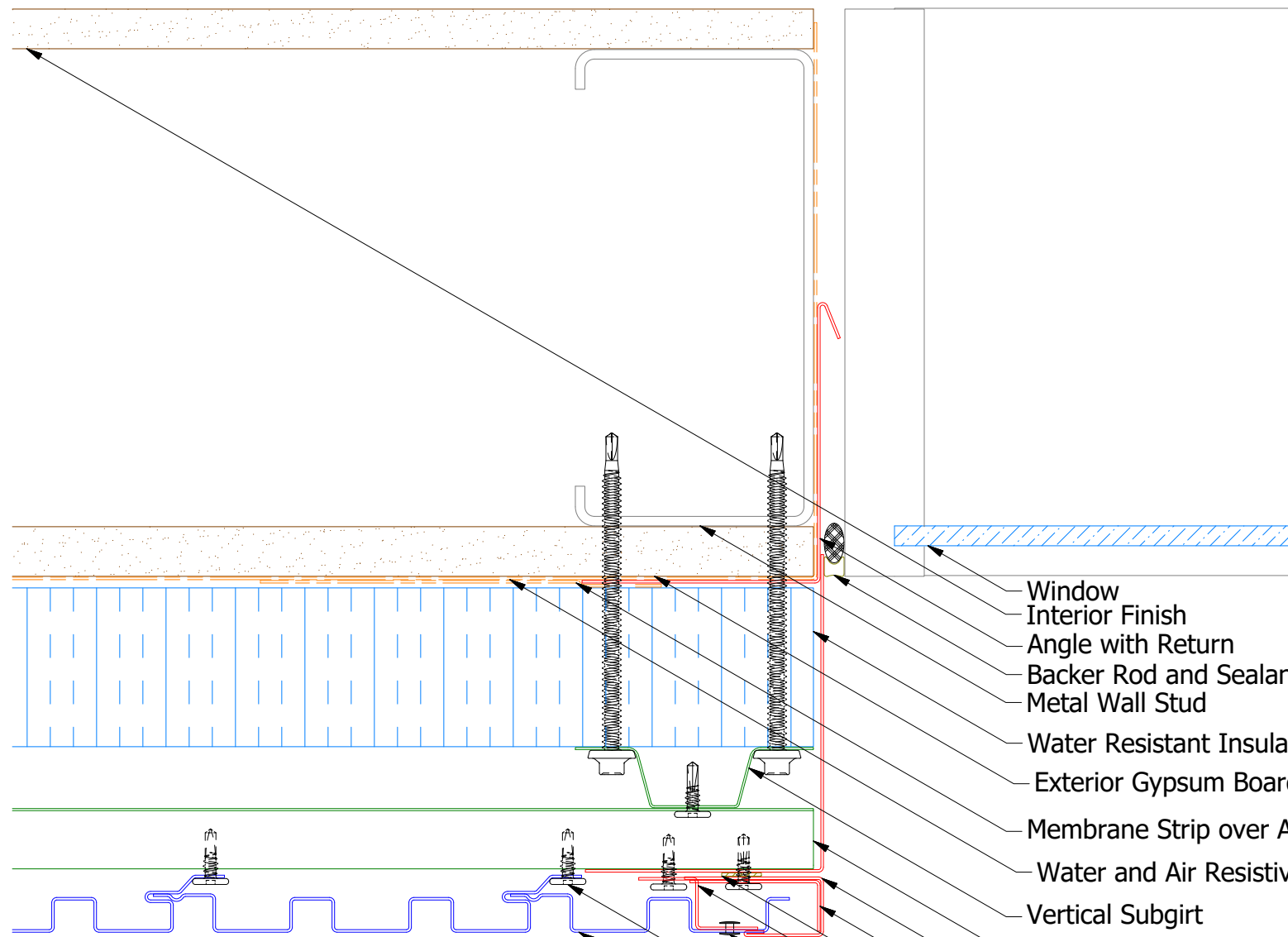

## Alternate Subgirt Orientation (NTS)

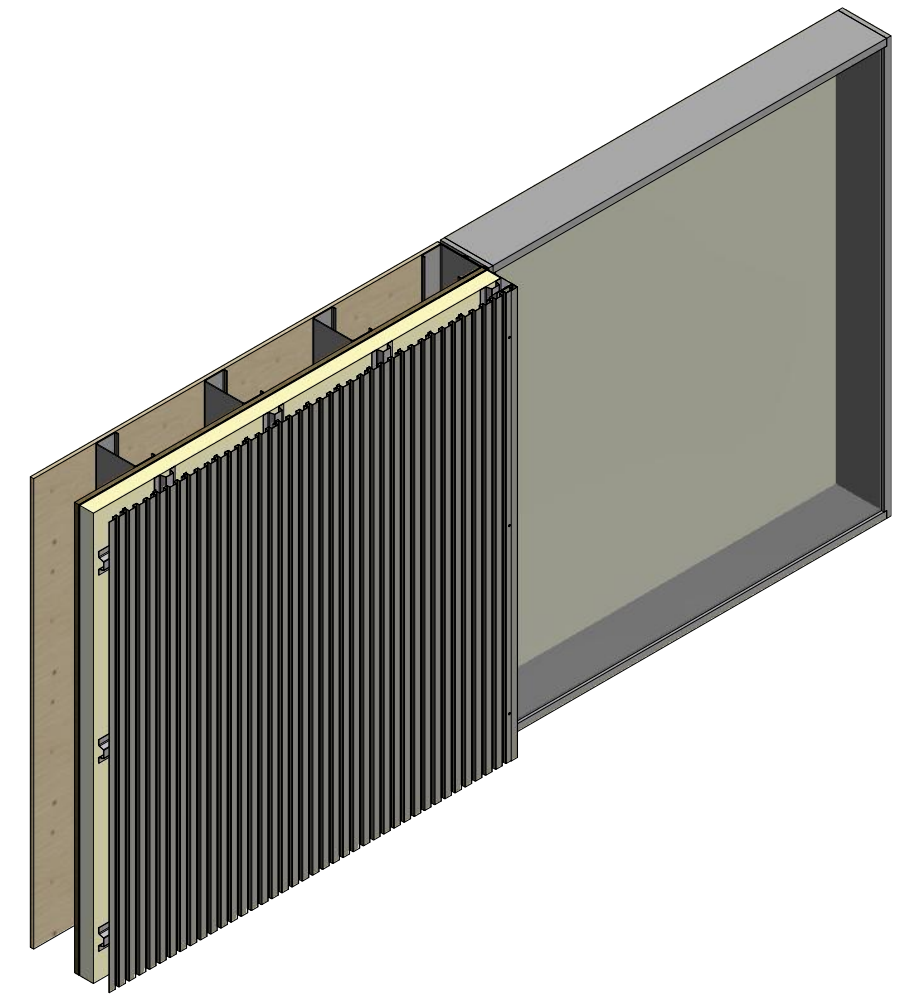
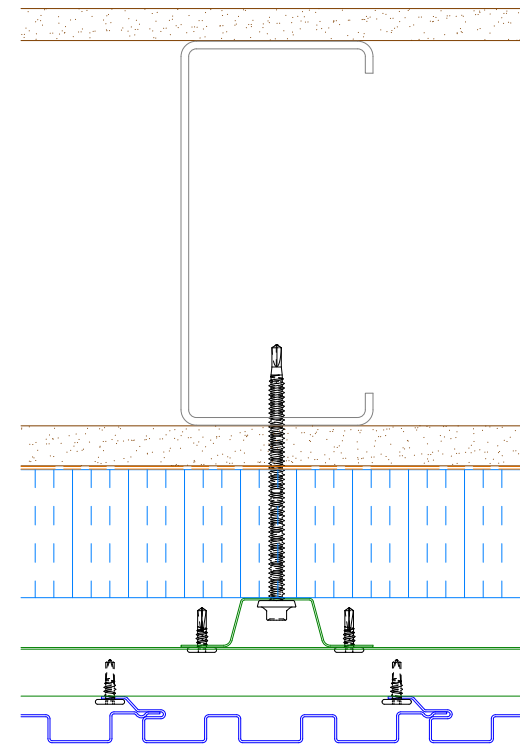

- Window
- Interior Finish
- Angle with Return
- Backer Rod and Sealant
- Metal Wall Stud
- Water Resistant Insulation
- Exterior Gypsum Board
- Membrane Strip over Angle with Return
- Water and Air Resistive Barrier
- Vertical Subgirt
- Horizontal Subgirt
- J Channel
- Angle Trim
- Butyl Tape
- Support Z
- Painted Pop Rivet
- #10 x 5/8" Wafer Head Fastener
- Opaline Panel

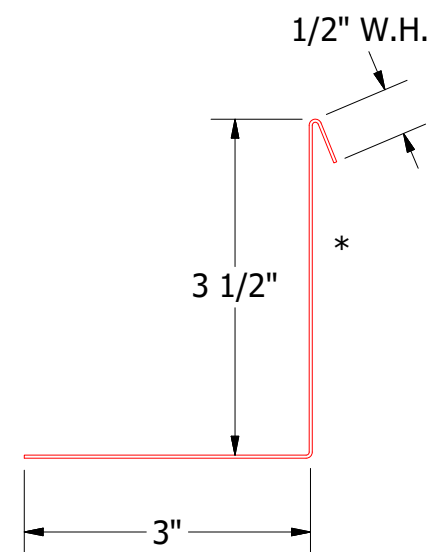

BGA683-Angle with Return

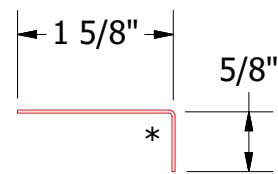

BGA680-Angle Trim

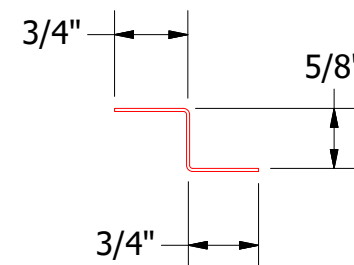

BGA681-Support Z

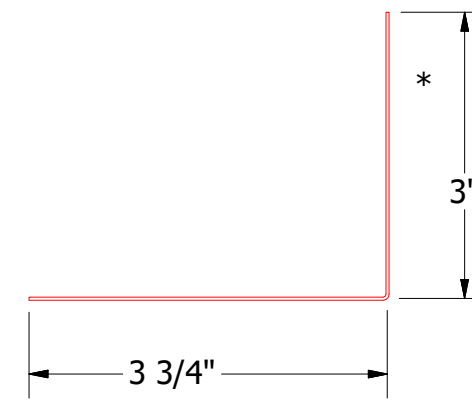

Angle

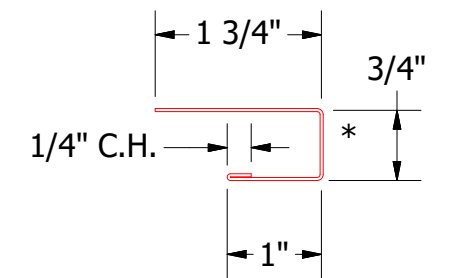

BGA034-J Channel

		<b>ATAS INTERNATIONAL, INC</b> Allentown PA 610-395-8445 Mesa AZ 480-558-7210	
		TITLE <b>Opaline Panel Open Jamb Detail</b>	
DWG. NO.	DR	DATE	10/10/2016
APP	DMR	DATE	
MATERIAL	SH. SIZE	B	SCALE X:X

REV. NO.	DATE	DESCRIPTION OF REVISION	BY	APP