

Horizontal Panel

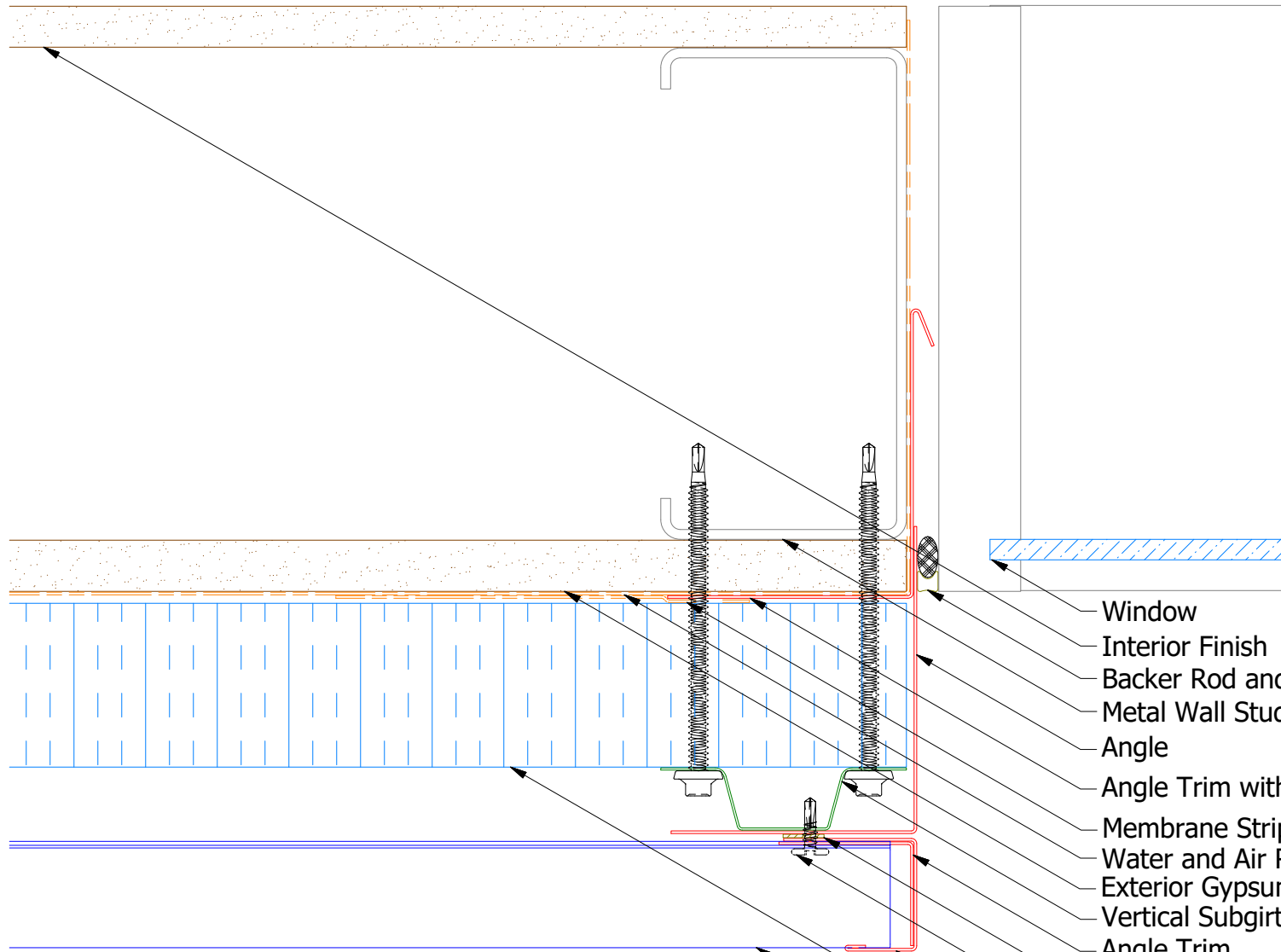

Alternate Subgirt Orientation (NTS)

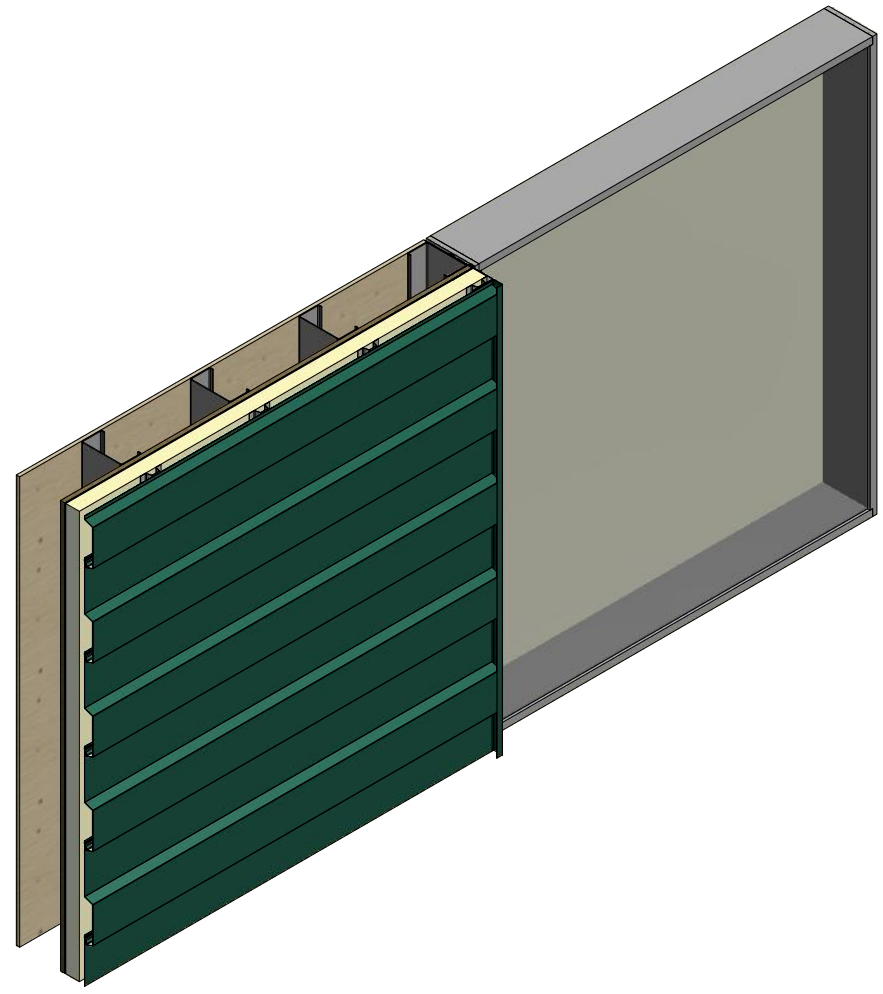
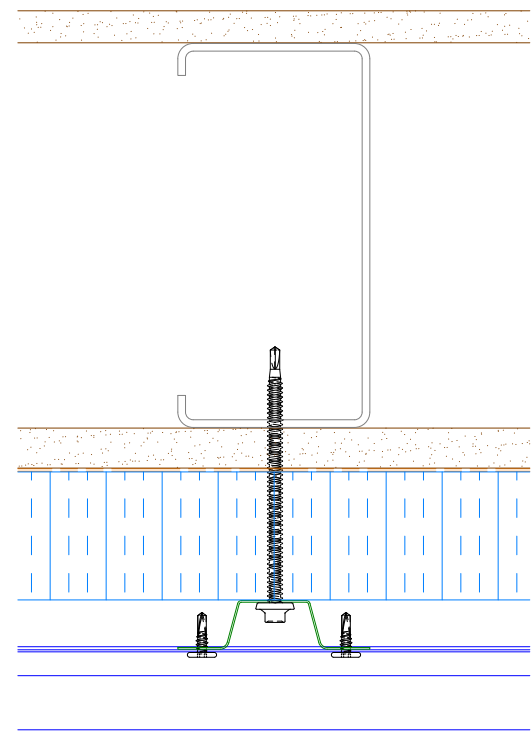

- Window
- Interior Finish
- Backer Rod and Sealant
- Metal Wall Stud
- Angle
- Angle Trim with Return
- Membrane Strip over Angle Trim with Return
- Water and Air Resistive Barrier
- Exterior Gypsum Board
- Vertical Subgirt
- Angle Trim
- Butyl Tape
- #10 x 5/8" Wafer Head Fastener
- J Channel
- Water Resistant Insulation
- Multi-Purpose Panel

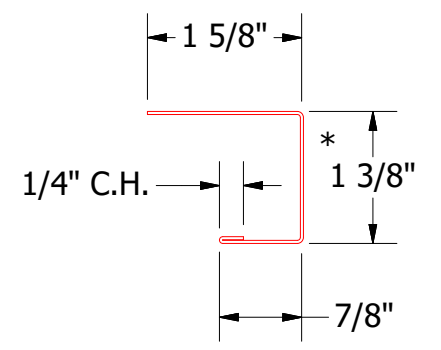

MPA138-J Channel

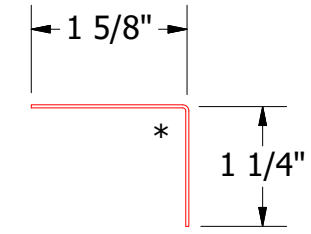

MPA680-Angle Trim

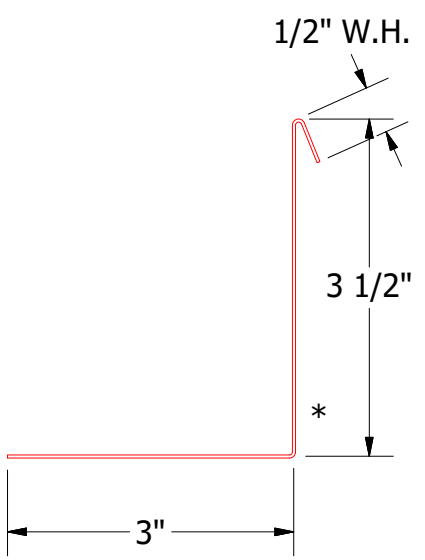

MPA683-Angle Trim with Return

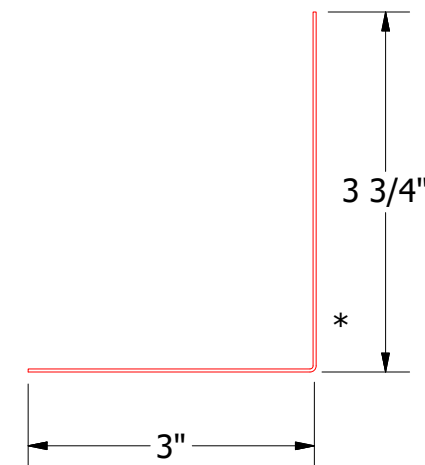

Angle

ATAS ATAS INTERNATIONAL, INC
 Allentown PA
 610-395-8445
 Mesa AZ
 480-558-7210

TITLE **Multi-Purpose Open Jamb Detail**

DWG. NO.	DR	DATE
	DMR	2/3/2017
MATERIAL	APP	DATE
	SH. SIZE	SCALE
	B	X:X

REV. NO.	DATE	DESCRIPTION OF REVISION	BY	APP