

SHED RIDGE CAP
 PCA342 - Roof Slopes 3/12+ to 6/12
 Ridge splice to match ridge cap @ 6' long each; PCA343

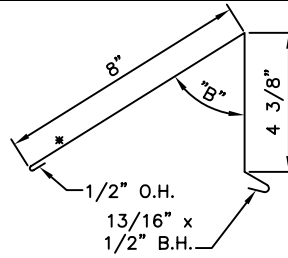

SHED RIDGE CAP
 PCA344 - Roof Slopes 6/12+ to 9/12
 Ridge splice to match ridge cap @ 6' long each; PCA345

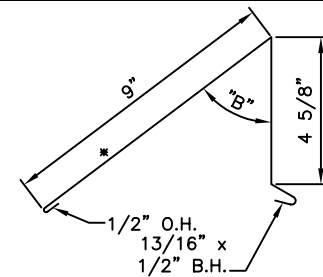

SHED RIDGE CAP
 PCA346 - Roof Slopes 9/12+ to 12/12
 Ridge splice to match ridge cap @ 6' long each; PCA347

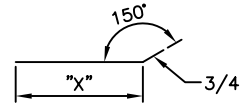
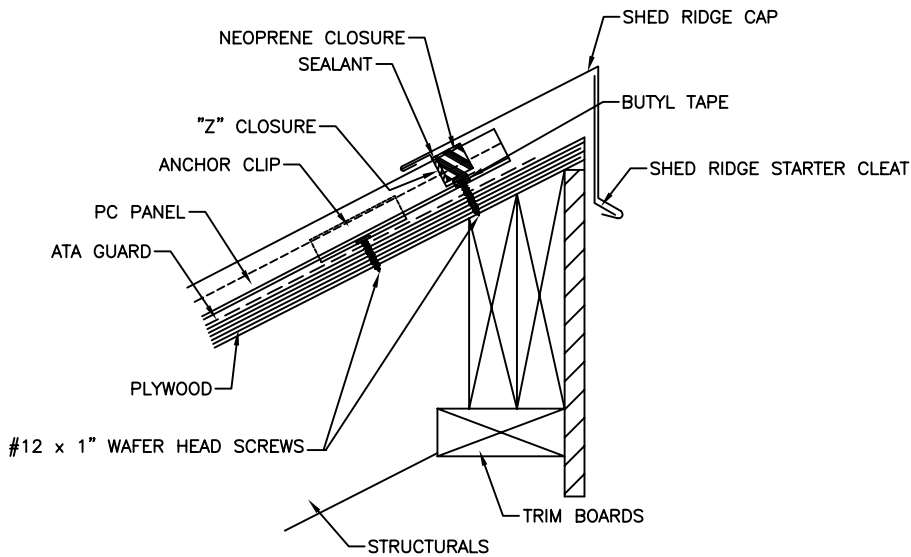

PCA348 - SHED RIDGE STARTER CLEAT

Note: This part furnished in either 24 ga. steel or .032 aluminum. - No specific color.

Dimension "X" is 1/8" shorter than dimension "C" on 24.

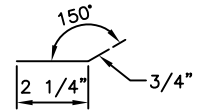

PCA995 - STANDARD STARTER CLEAT

Note: This part furnished in either 24 ga. steel or .032 aluminum. - No specific color.

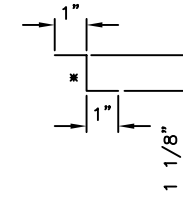

PCA910 - 'Z' CLOSURE

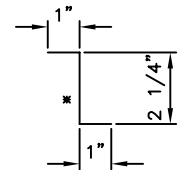

PCA912 - 'Z' CLOSURE

Note: Combination shed ridge support and starter cleat could, at the discretion of the installer, be replaced by a standard starter cleat.

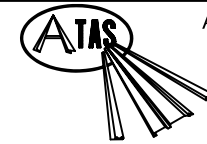

ATAS INTERNATIONAL, INC.

Allentown PA
 610-395-8445
 Mesa AZ
 480-558-7210

TITLE		PC Panel Shed Ridge - ply					
DWG NO. / FILE NO.		PC Panel Shed Ridge - ply			SCALE	3"=1'-0"	
DRAWN BY	DAS	DATE	3-6-06	APPR. BY	JEB	DATE	6-2-06
REVISION NO.	XXXX	REVISION DATE	MM/DD/YY	APPR. BY	XXXX	APPR. DATE	MM/DD/YY

Rev. No.	Revision Date	Drawn By	Description of Revision
0	6-2-06	DAS	PC Panel Shed Ridge - ply