

ATAS INTERNATIONAL, INC.
 Allentown PA
 610-395-8445
 Mesa AZ
 480-558-7210

TITLE		Metafor Horizontal Inside Corner					
DWG NO. / FILE NO.		Metafor Horizontal Inside Corner				SCALE	3"=1'-0"
DRAWN BY	DAS	DATE	3-6-06	APPR. BY	JEB	DATE	6-2-06
REVISION NO.	XXXX	REVISION DATE	MM/DD/YY	APPR. BY	XXXX	APPR. DATE	MM/DD/YY

Rev. No.	Revision Date	Drawn By	Description of Revision
0	6-2-06	DAS	Metafor Horizontal Inside Corner

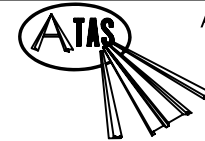
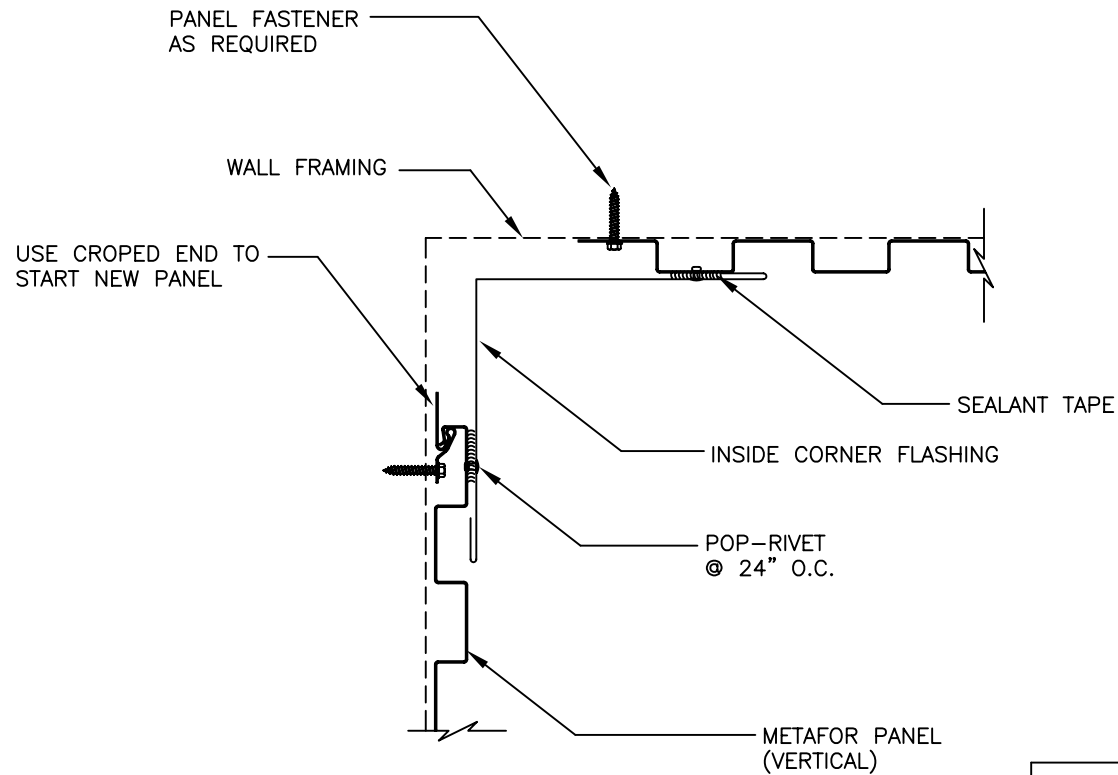

ATAS INTERNATIONAL, INC.
 Allentown PA
 610-395-8445
 Mesa AZ
 480-558-7210

TITLE		Metafor Vertical Inside Corner					
DWG NO. / FILE NO.		Metafor Vertical Inside Corner				SCALE	3"=1'-0"
DRAWN BY	DAS	DATE	3-6-06	APPR. BY	JEB	DATE	6-2-06
REVISION NO.	XXXX	REVISION DATE	MM/DD/YY	APPR. BY	XXXX	APPR. DATE	MM/DD/YY

Rev. No.	Revision Date	Drawn By	Description of Revision
0	6-2-06	DAS	Metafor Vertical Inside Corner

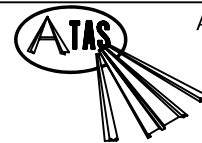
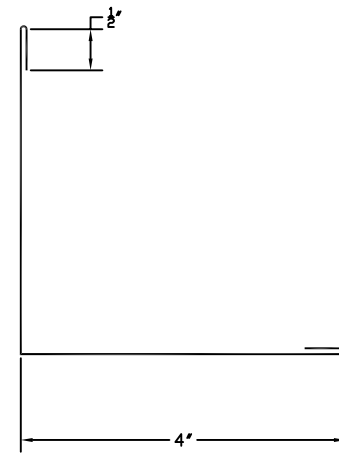
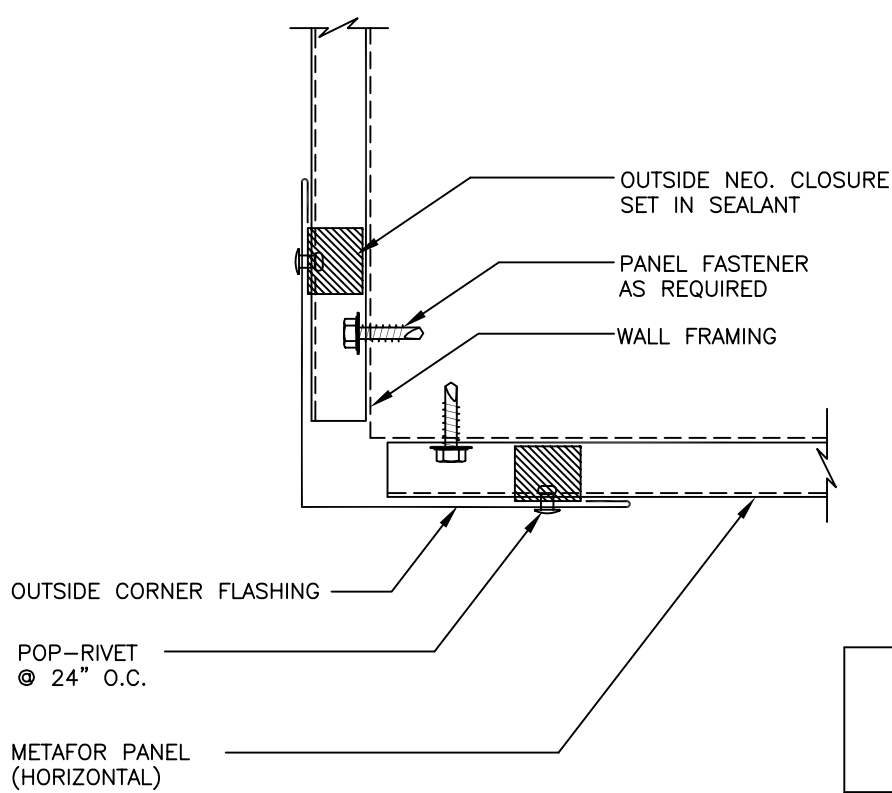

ATAS INTERNATIONAL, INC.
 Allentown PA
 610-395-8445
 Mesa AZ
 480-558-7210

TITLE **Metafor Horizontal Outside Corner**

DWG NO. / FILE NO. **Metafor Horizontal Outside Corner** SCALE **3"=1'-0"**

DRAWN BY **DAS** DATE **3-6-06** APPR. BY **JEB** DATE **6-2-06**

REVISION NO. **XXXX** REVISION DATE **MM/DD/YY** APPR. BY **XXXX** APPR. DATE **MM/DD/YY**

Rev. No.	Revision Date	Drawn By	Description of Revision
0	6-2-06	DAS	Metafor Horizontal Outside Corner

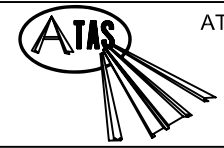
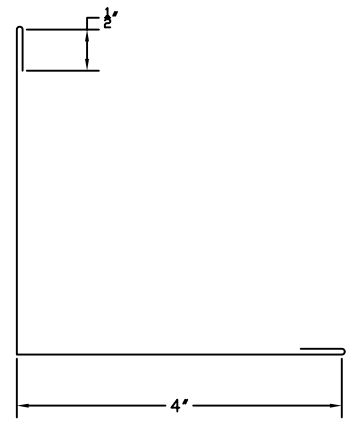
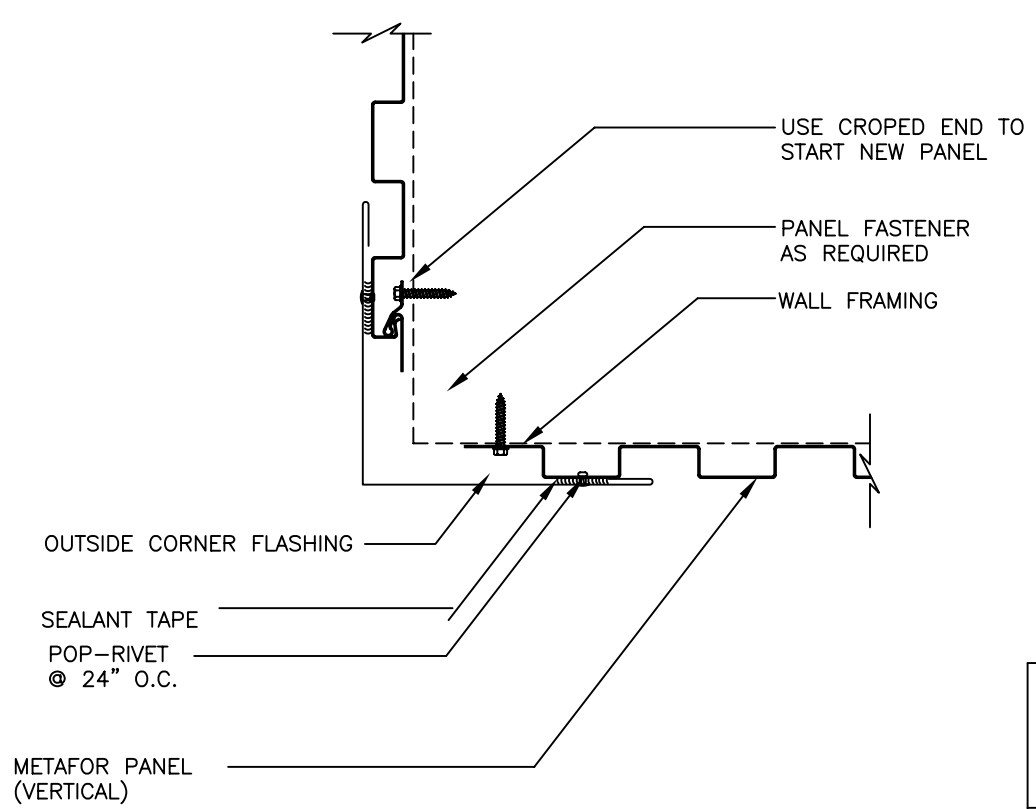

ATAS INTERNATIONAL, INC.
 Allentown PA
 610-395-8445
 Mesa AZ
 480-558-7210

TITLE Metafor Vertical Outside Corner							
DWG NO. / FILE NO. Metafor Vertical Outside Corner						SCALE 3"=1'-0"	
DRAWN BY DAS		DATE 3-6-06		APPR. BY JEB		DATE 6-2-06	
REVISION NO. XXXX		REVISION DATE MM/DD/YY		APPR. BY XXXX		APPR. DATE MM/DD/YY	

Rev. No.	Revision Date	Drawn By	Description of Revision
0	6-2-06	DAS	Metafor Vertical Outside Corner

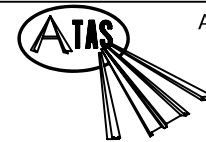
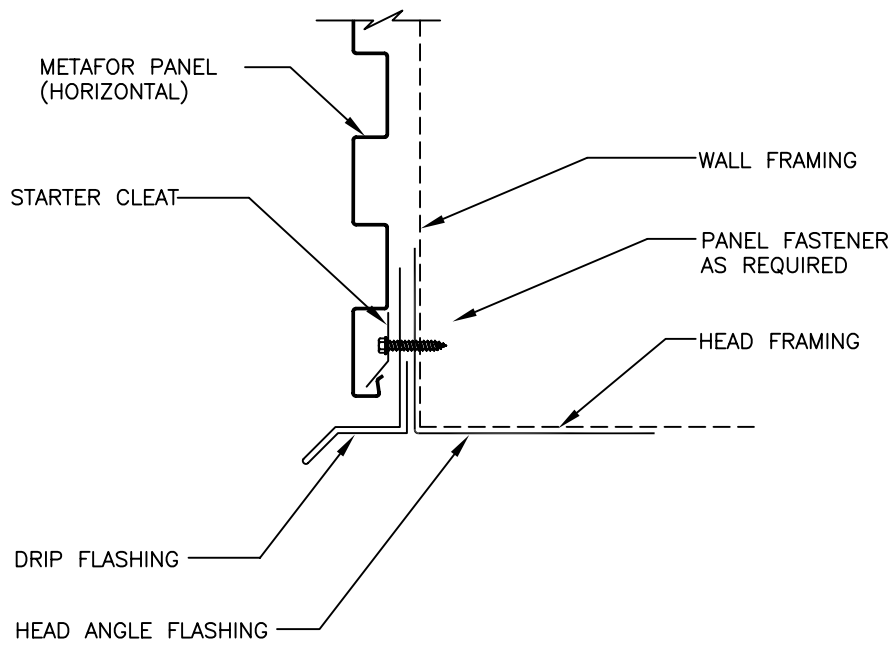

ATAS INTERNATIONAL, INC.
 Allentown PA
 610-395-8445
 Mesa AZ
 480-558-7210

TITLE										Metafor Horizontal Head			
DWG NO. / FILE NO.		Metafor Horizontal Head						SCALE		3"=1'-0"			
DRAWN BY	DAS	DATE	3-6-06	APPR. BY	JEB	DATE	6-2-06						
REVISION NO.	XXXX	REVISION DATE	MM/DD/YY	APPR. BY	XXXX	APPR. DATE	MM/DD/YY						

Rev. No.	Revision Date	Drawn By	Description of Revision
0	6-2-06	DAS	Metafor Horizontal Head

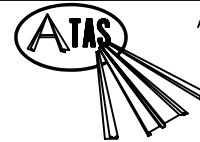
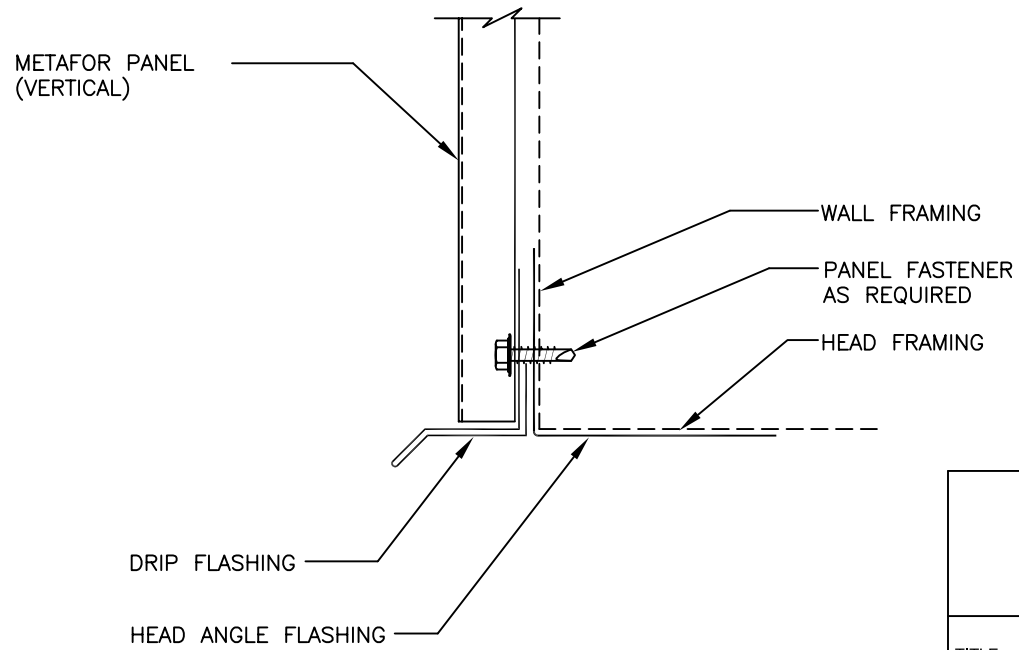

ATAS INTERNATIONAL, INC.
 Allentown PA
 610-395-8445
 Mesa AZ
 480-558-7210

TITLE **Metafor Vertical Head**

DWG NO. / FILE NO. **Metafor Vertical Head** SCALE **3"=1'-0"**

DRAWN BY **DAS** DATE **3-6-06** APPR. BY **JEB** DATE **6-2-06**

REVISION NO. **XXXX** REVISION DATE **MM/DD/YY** APPR. BY **XXXX** APPR. DATE **MM/DD/YY**

Rev. No.	Revision Date	Drawn By	Description of Revision
0	6-2-06	DAS	Metafor Vertical Head

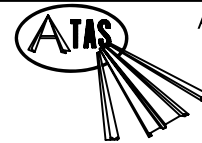
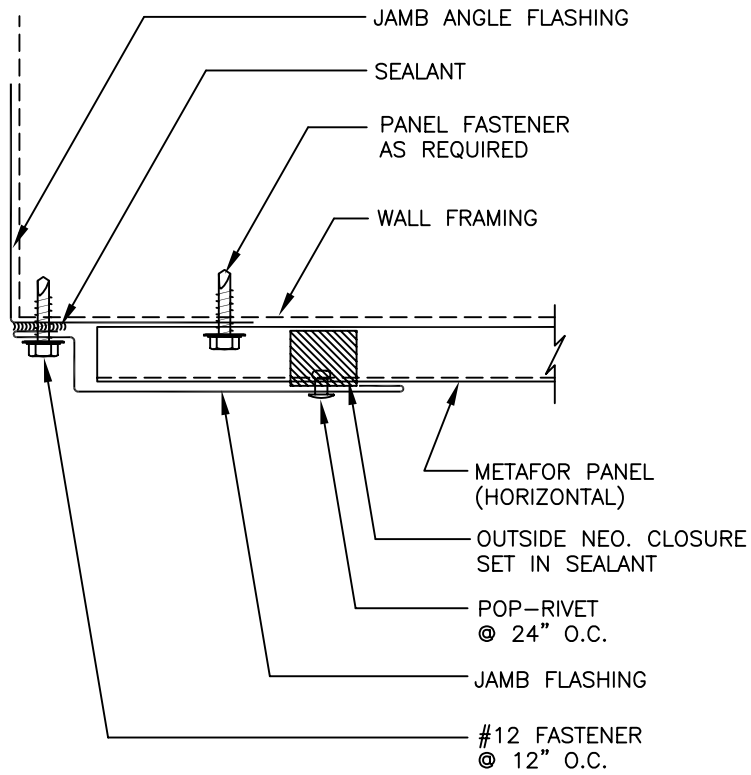

ATAS INTERNATIONAL, INC.
 Allentown PA
 610-395-8445
 Mesa AZ
 480-558-7210

TITLE **Metafor Horizontal Jamb**

DWG NO. / FILE NO. **Metafor Horizontal Jamb** SCALE **3"=1'-0"**

DRAWN BY **DAS** DATE **3-6-06** APPR. BY **JEB** DATE **6-2-06**

REVISION NO. **XXXX** REVISION DATE **MM/DD/YY** APPR. BY **XXXX** APPR. DATE **MM/DD/YY**

Rev. No.	Revision Date	Drawn By	Description of Revision
0	6-2-06	DAS	Metafor Horizontal Jamb

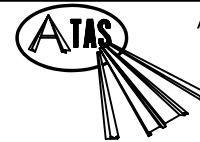
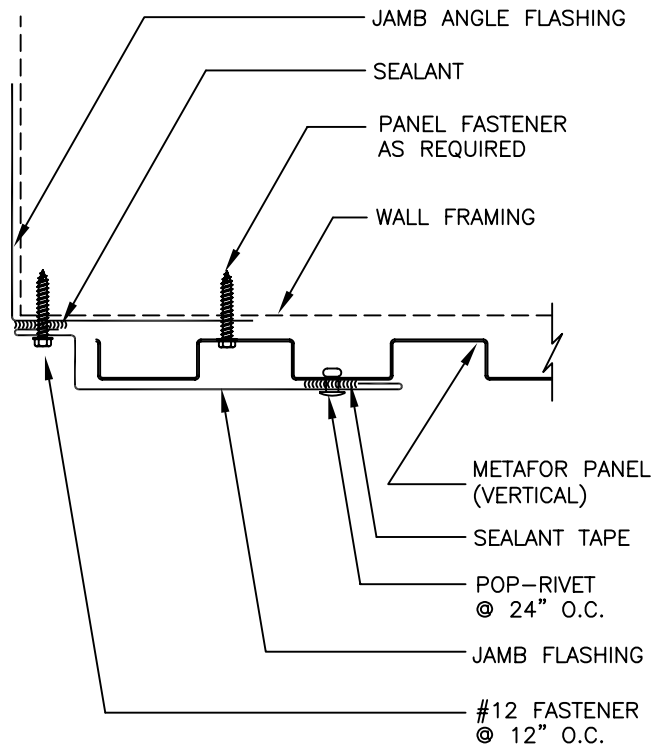

ATAS INTERNATIONAL, INC.
 Allentown PA
 610-395-8445
 Mesa AZ
 480-558-7210

TITLE								Metafor Vertical Jamb			
DWG NO. / FILE NO.				Metafor Vertical Jamb				SCALE		3"=1'-0"	
DRAWN BY		DAS		DATE		3-6-06		APPR. BY		JEB	
REVISION NO.		XXXX		REVISION DATE		MM/DD/YY		APPR. BY		XXXX	
DATE		6-2-06		DATE		6-2-06		DATE		MM/DD/YY	

Rev. No.	Revision Date	Drawn By	Description of Revision
0	6-2-06	DAS	Metafor Vertical Jamb

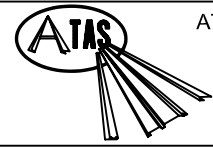
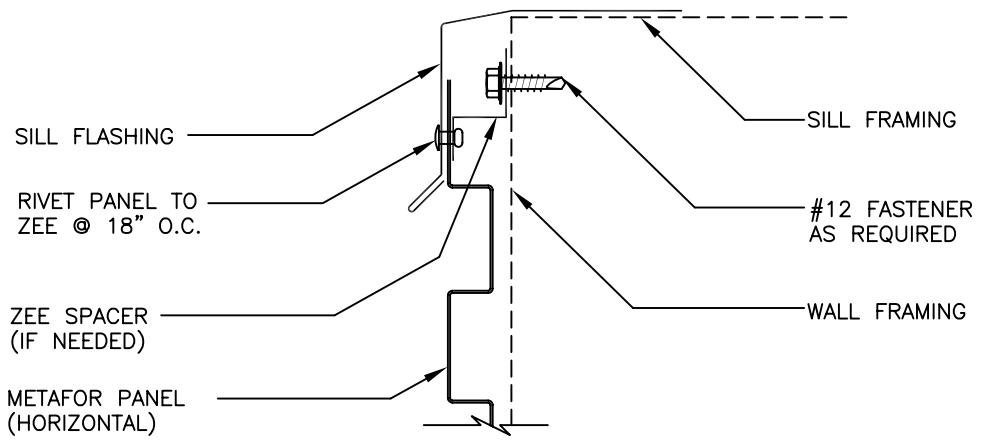

ATAS INTERNATIONAL, INC.
 Allentown PA
 610-395-8445
 Mesa AZ
 480-558-7210

TITLE		Metafor Horizontal Sill					
DWG NO. / FILE NO.		Metafor Horizontal Sill				SCALE	3"=1'-0"
DRAWN BY	DAS	DATE	3-6-06	APPR. BY	JEB	DATE	6-2-06
REVISION NO.	XXXX	REVISION DATE	MM/DD/YY	APPR. BY	XXXX	APPR. DATE	MM/DD/YY

Rev. No.	Revision Date	Drawn By	Description of Revision
0	6-2-06	DAS	Metafor Horizontal Sill

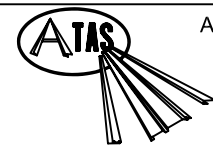
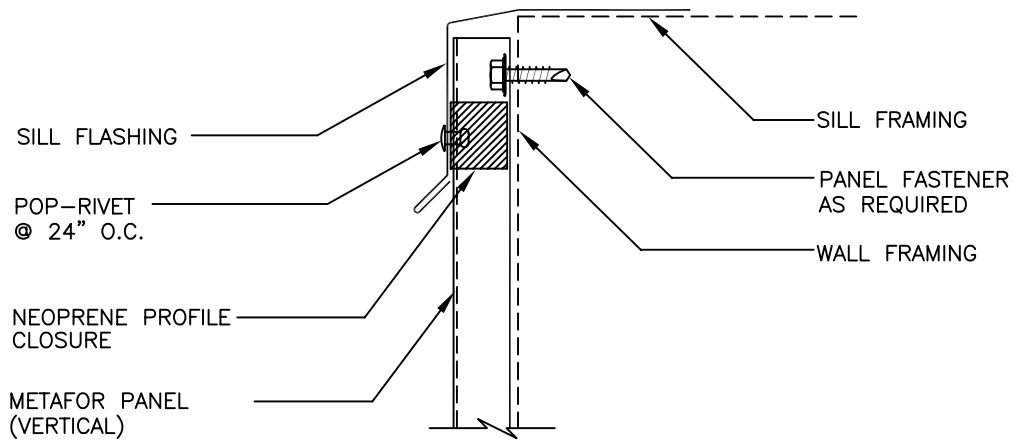

ATAS INTERNATIONAL, INC.
 Allentown PA
 610-395-8445
 Mesa AZ
 480-558-7210

TITLE **Metafor Vertical Sill**

DWG NO. / FILE NO. **Metafor Vertical Sill** SCALE **3"=1'-0"**

Rev. No.	Revision Date	Drawn By	Description of Revision	DRAWN BY	DAS	DATE	3-6-06	APPR. BY	JEB	DATE	6-2-06
0	6-2-06	DAS	Metafor Vertical Sill	REVISION NO.	XXXX	REVISION DATE	MM/DD/YY	APPR. BY	XXXX	APPR. DATE	MM/DD/YY

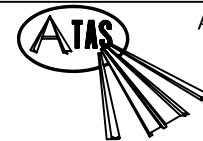
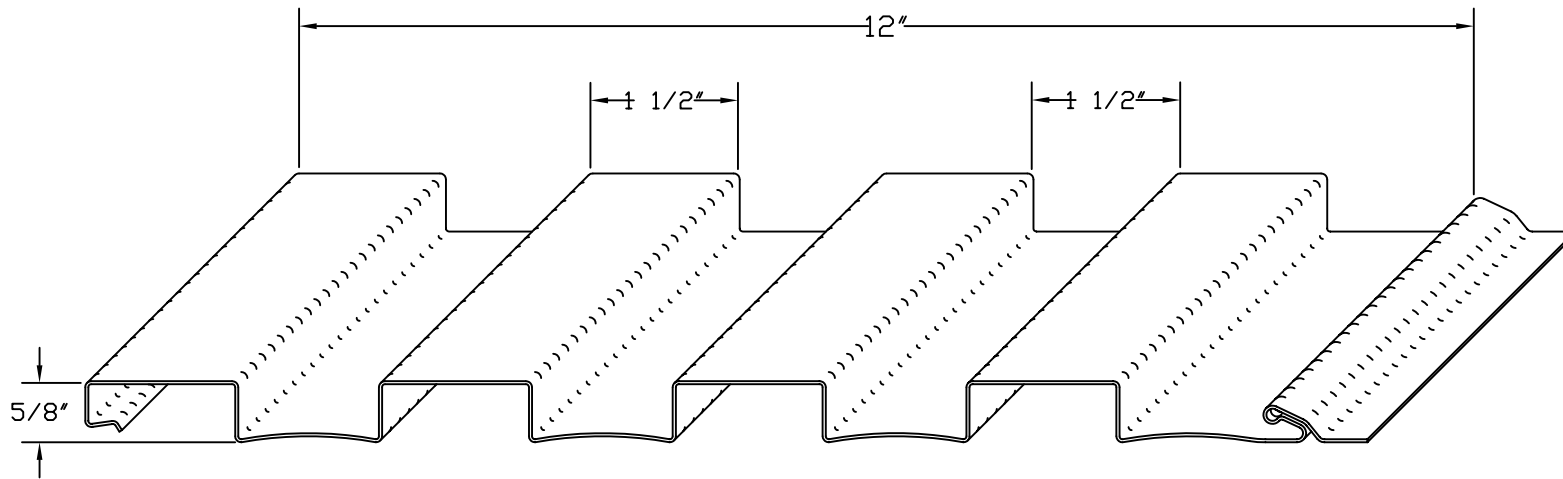

ATAS INTERNATIONAL, INC.
 Allentown PA
 610-395-8445
 Mesa AZ
 480-558-7210

TITLE								MFP Profile	
DWG NO. / FILE NO.				MFP Profile				SCALE	3"=1'-0"
DRAWN BY	DAS	DATE	7-25-07	APPR. BY	JEB	DATE	7-25-07		
REVISION NO.	XXXX	REVISION DATE	MM/DD/YY	APPR. BY	XXXX	APPR. DATE	MM/DD/YY		

Rev. No.	Revision Date	Drawn By	Description of Revision
0	7-25-07	DAS	MFP Profile

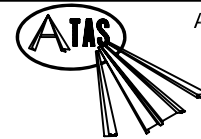
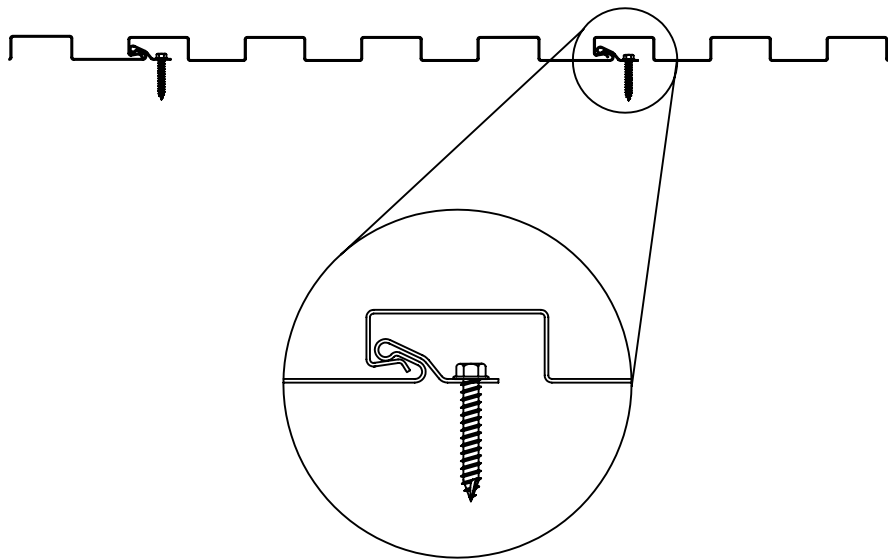

ATAS INTERNATIONAL, INC.
 Allentown PA
 610-395-8445
 Mesa AZ
 480-558-7210

TITLE		Metafor Overlap Fastening					
DWG NO. / FILE NO.		Metafor Overlap Fastening				SCALE	3"=1'-0"
DRAWN BY	DAS	DATE	3-6-06	APPR. BY	JEB	DATE	6-1-06
REVISION NO.	XXXX	REVISION DATE	MM/DD/YY	APPR. BY	XXXX	APPR. DATE	MM/DD/YY

Rev. No.	Revision Date	Drawn By	Description of Revision
0	6-1-06	DAS	Metafor Overlap Fastening

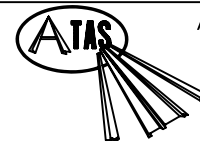
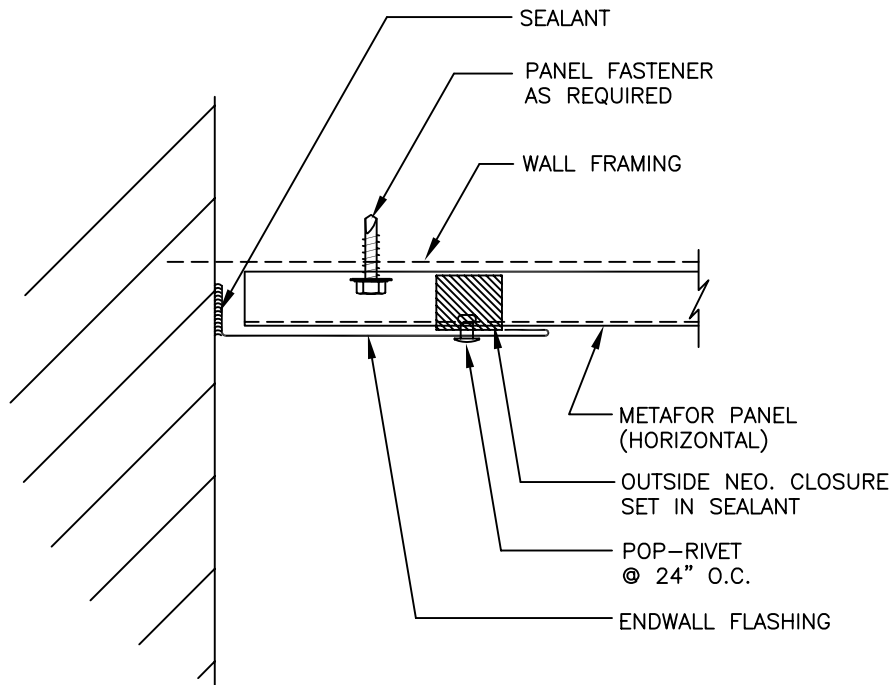

ATAS INTERNATIONAL, INC.
 Allentown PA
 610-395-8445
 Mesa AZ
 480-558-7210

TITLE		Metafor Horizontal Endwall					
DWG NO. / FILE NO.		Metafor Horizontal Endwall				SCALE	3"=1'-0"
DRAWN BY	DAS	DATE	3-6-06	APPR. BY	JEB	DATE	6-2-06
REVISION NO.	XXXX	REVISION DATE	MM/DD/YY	APPR. BY	XXXX	APPR. DATE	MM/DD/YY

Rev. No.	Revision Date	Drawn By	Description of Revision
0	6-2-06	DAS	Metafor Horizontal Endwall

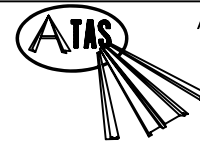
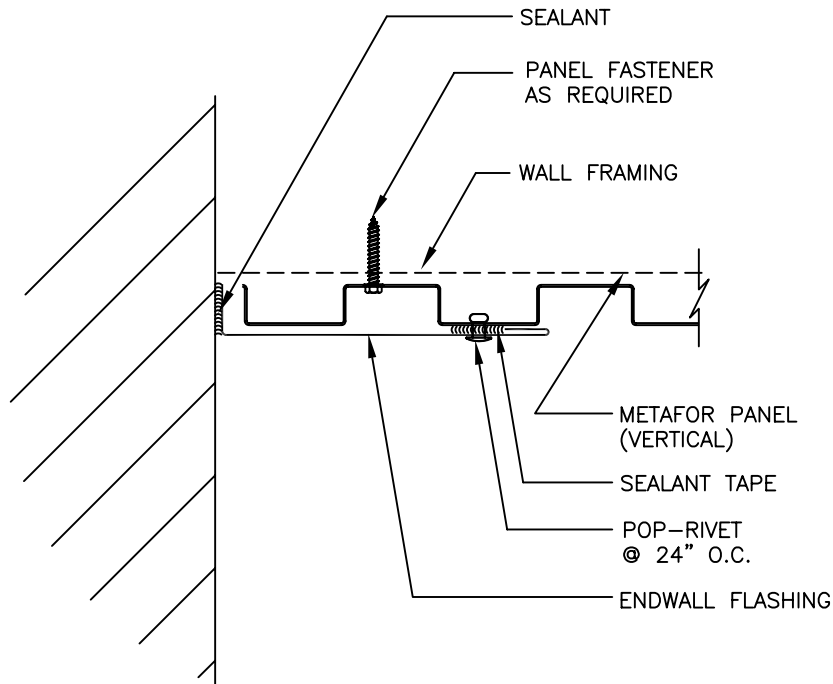

ATAS INTERNATIONAL, INC.
 Allentown PA
 610-395-8445
 Mesa AZ
 480-558-7210

TITLE		Metafor Vertical Endwall					
DWG NO. / FILE NO.		Metafor Vertical Endwall				SCALE	3"=1'-0"
DRAWN BY	DAS	DATE	3-6-06	APPR. BY	JEB	DATE	6-2-06
REVISION NO.	XXXX	REVISION DATE	MM/DD/YY	APPR. BY	XXXX	APPR. DATE	MM/DD/YY

Rev. No.	Revision Date	Drawn By	Description of Revision
0	6-2-06	DAS	Metafor Vertical Endwall