

ATAS INTERNATIONAL, INC.
 Allentown PA
 610-395-8445
 Mesa AZ
 480-558-7210

TITLE Corra-Lok Horizontal Inside Corner

DWG NO. / FILE NO. Corra-Lok Horizontal Inside Corner SCALE 3"=1'-0"

DRAWN BY DAS DATE 4-12-07 APPR. BY JEB DATE 4-12-07

REVISION NO. XXXX REVISION DATE MM/DD/YY APPR. BY XXXX APPR. DATE MM/DD/YY

Rev. No.	Revision Date	Drawn By	Description of Revision
0	4-12-07	DAS	Corra-Lok Horizontal Inside Corner

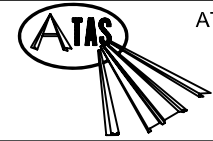
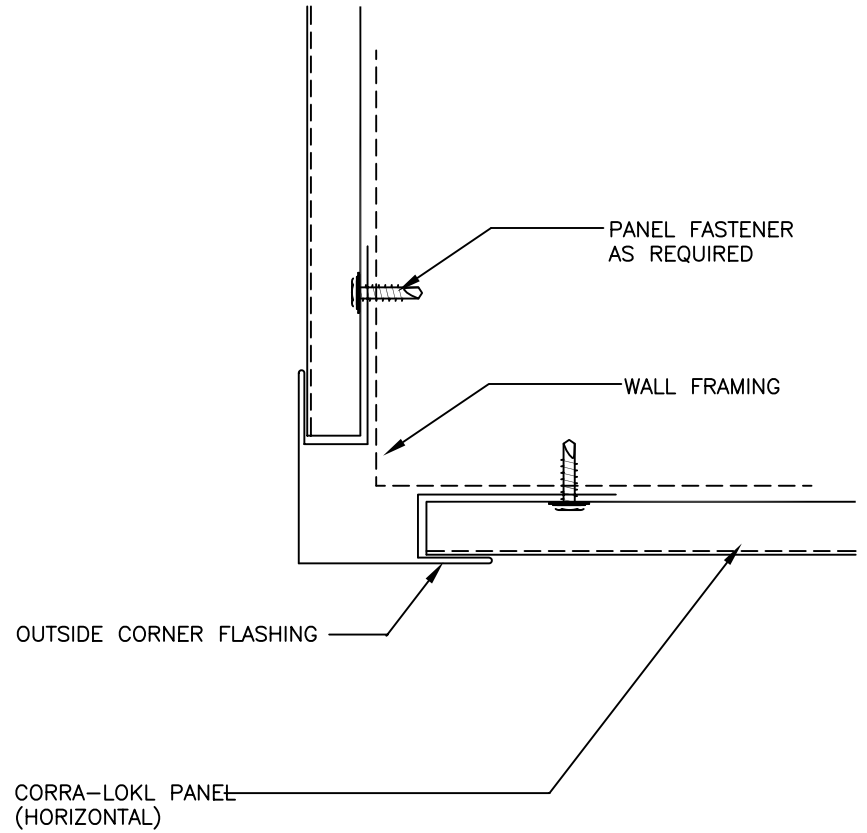
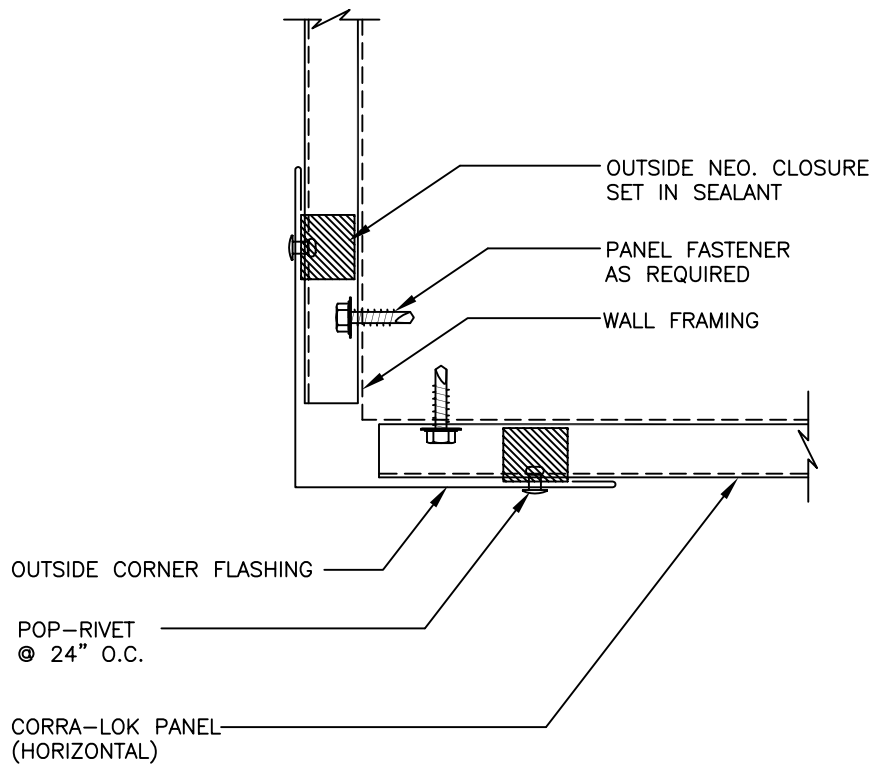

ATAS INTERNATIONAL, INC.
 Allentown PA
 610-395-8445
 Mesa AZ
 480-558-7210

TITLE		Corra-Lok Horizontal Outside Corner					
DWG NO. / FILE NO.		Corra-Lok Horizontal Outside Corner				SCALE	3"=1'-0"
DRAWN BY	DAS	DATE	4-12-07	APPR. BY	JEB	DATE	4-12-07
REVISION NO.	XXXX	REVISION DATE	MM/DD/YY	APPR. BY	XXXX	APPR. DATE	MM/DD/YY

Rev. No.	Revision Date	Drawn By	Description of Revision
0	4-12-07	DAS	Corra-Lok Horizontal Outside Corner

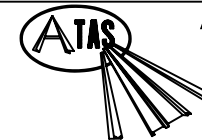
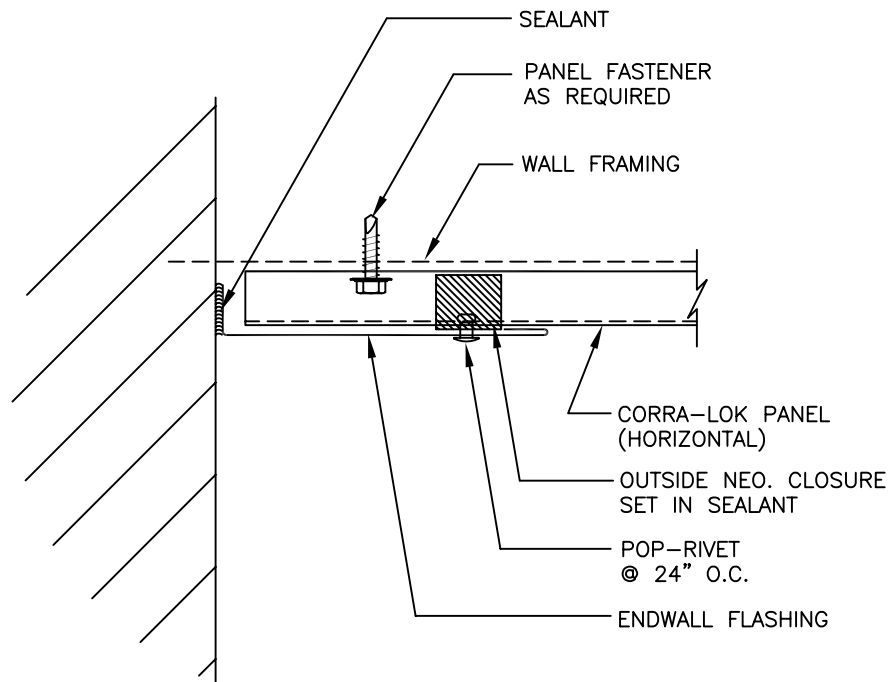

ATAS INTERNATIONAL, INC.
 Allentown PA
 610-395-8445
 Mesa AZ
 480-558-7210

TITLE Corra-Lok Horizontal Endwall

DWG NO. / FILE NO. Corra-Lok Horizontal Endwall SCALE 3"=1'-0"

DRAWN BY DAS DATE 4-12-07 APPR. BY JEB DATE 4-12-07

REVISION NO. XXXX REVISION DATE MM/DD/YY APPR. BY XXXX APPR. DATE MM/DD/YY

Rev. No.	Revision Date	Drawn By	Description of Revision
0	4-12-07	DAS	Corra-Lok Horizontal Endwall

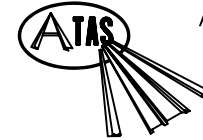
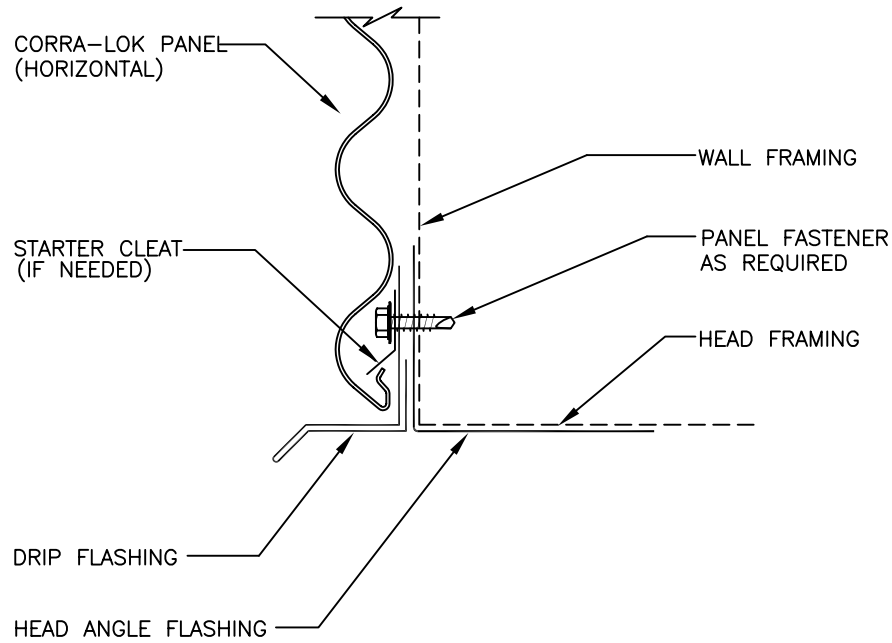

ATAS INTERNATIONAL, INC.
 Allentown PA
 610-395-8445
 Mesa AZ
 480-558-7210

TITLE		Corra-Lok Horizontal Head					
DWG NO. / FILE NO.		Corra-Lok Horizontal Head				SCALE	3"=1'-0"
DRAWN BY	DAS	DATE	4-12-07	APPR. BY	JEB	DATE	4-12-07
REVISION NO.	XXXX	REVISION DATE	MM/DD/YY	APPR. BY	XXXX	APPR. DATE	MM/DD/YY

Rev. No.	Revision Date	Drawn By	Description of Revision
0	4-12-07	DAS	Corra-Lok Horizontal Head

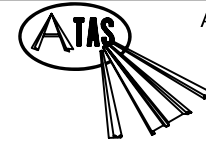
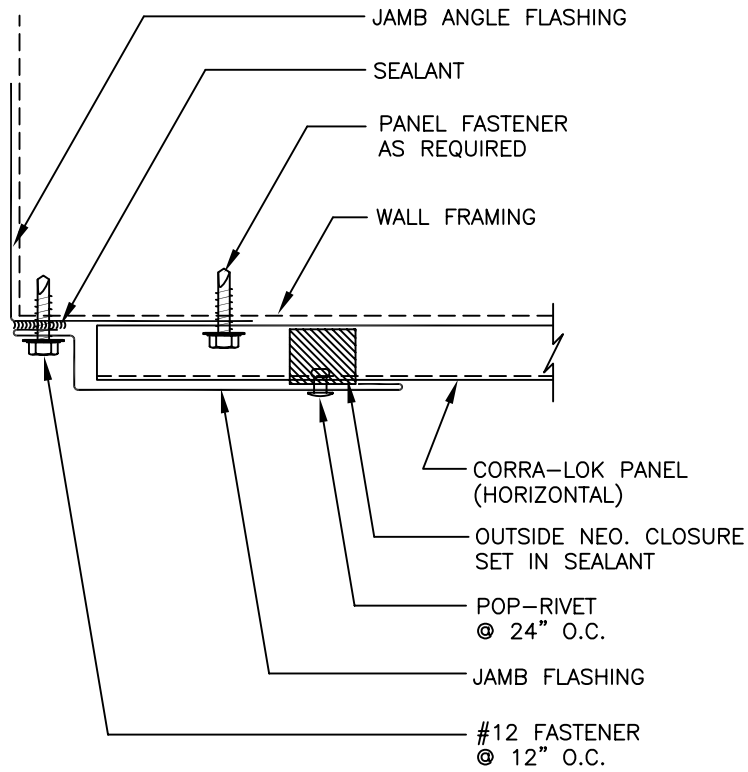

ATAS INTERNATIONAL, INC.
 Allentown PA
 610-395-8445
 Mesa AZ
 480-558-7210

TITLE Corra-Lok Horizontal Jamb

DWG NO. / FILE NO. Corra-Lok Horizontal Jamb SCALE 3"=1'-0"

DRAWN BY DAS DATE 4-12-07 APPR. BY JEB DATE 4-12-07

REVISION NO. XXXX REVISION DATE MM/DD/YY APPR. BY XXXX APPR. DATE MM/DD/YY

Rev. No.	Revision Date	Drawn By	Description of Revision
0	4-12-07	DAS	Corra-Lok Horizontal Jamb

Rev. No.	Revision Date	Drawn By	Description of Revision
0	4-12-07	DAS	Corra-Lok Horizontal Jamb

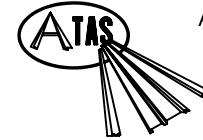
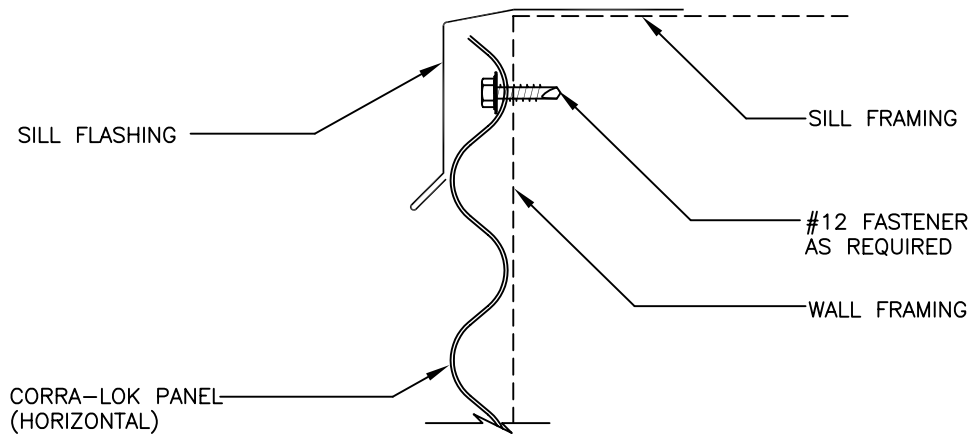

ATAS INTERNATIONAL, INC.
 Allentown PA
 610-395-8445
 Mesa AZ
 480-558-7210

TITLE		Corra-Lok Horizontal Sill					
DWG NO. / FILE NO.		Corra-Lok Horizontal Sill				SCALE	3"=1'-0"
DRAWN BY	DAS	DATE	4-12-07	APPR. BY	JEB	DATE	4-12-07
REVISION NO.	XXXX	REVISION DATE	MM/DD/YY	APPR. BY	XXXX	APPR. DATE	MM/DD/YY

Rev. No.	Revision Date	Drawn By	Description of Revision
0	4-12-07	DAS	Corra-Lok Horizontal Sill

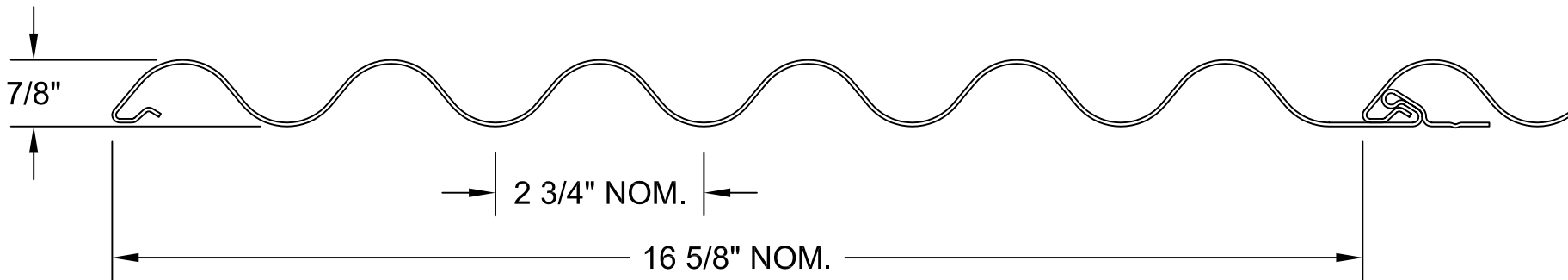
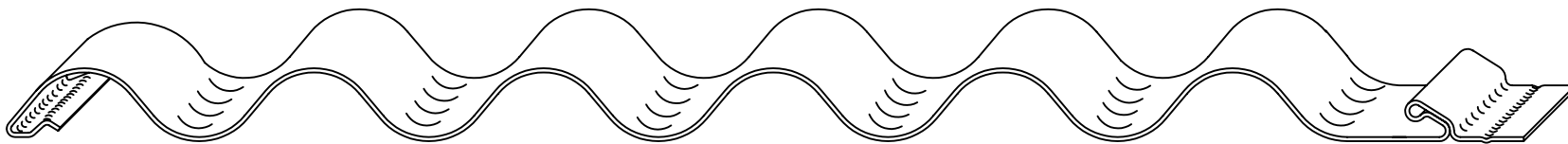

ATAS INTERNATIONAL, INC.
 Allentown PA
 610-395-8445
 Mesa AZ
 480-558-7210

TITLE		CONCEALED FASTENER CORRUGATED					
DWG NO. / FILE NO.		MFC160 - Sales			SCALE	X:Y	
DRAWN BY	RRG	DATE	01/18/07	APPR. BY	XXX	DATE	MM/DD/05
REVISION NO.	XXXX	REVISION DATE	MM/DD/YY	APPR. BY	XXXX	APPR. DATE	MM/DD/YY