

ATAS INTERNATIONAL, INC.  
 Allentown PA  
 610-395-8445  
 Mesa AZ  
 480-558-7210

TITLE		OPW Inside Corner					
DWG NO. / FILE NO.		OPW Inside Corner				SCALE	3"=1'-0"
DRAWN BY	DAS	DATE	3-6-06	APPR. BY	JEB	DATE	6-1-06
REVISION NO.	XXXX	REVISION DATE	MM/DD/YY	APPR. BY	XXXX	APPR. DATE	MM/DD/YY

Rev. No.	Revision Date	Drawn By	Description of Revision
0	6-1-06	DAS	OPW Inside Corner

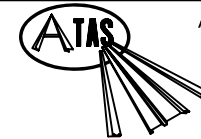
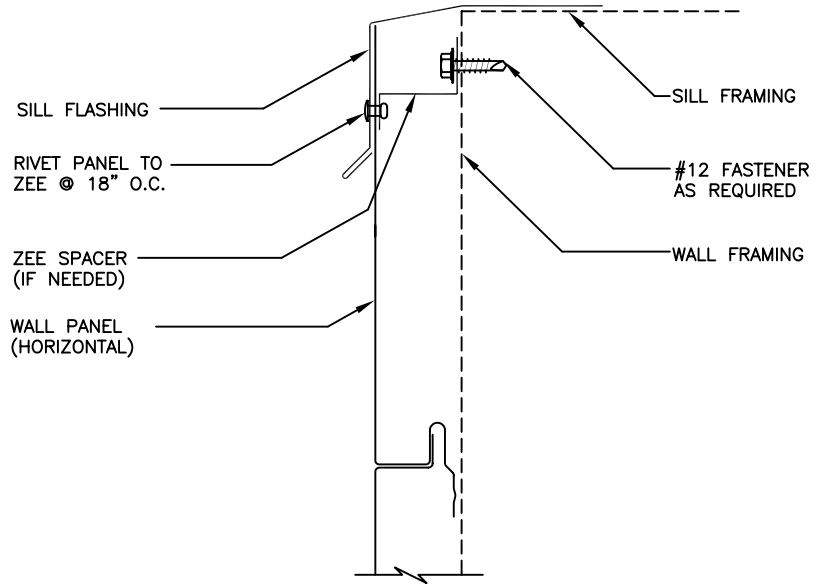
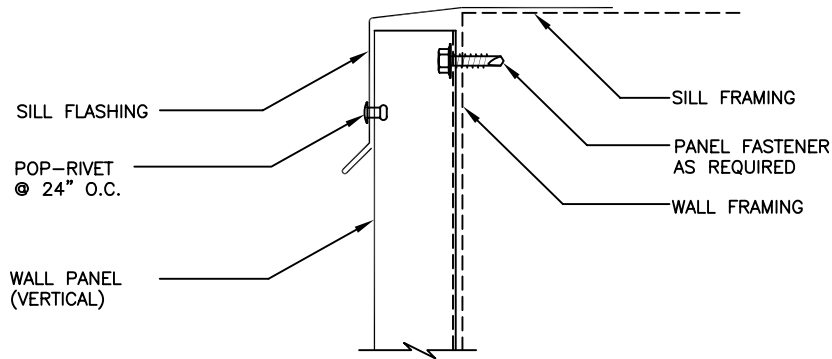

ATAS INTERNATIONAL, INC.  
 Allentown PA  
 610-395-8445  
 Mesa AZ  
 480-558-7210

TITLE										<b>OPW Sills</b>	
DWG NO. / FILE NO.				<b>OPW Sills</b>				SCALE	3"=1'-0"		
DRAWN BY	DAS	DATE	3-6-06	APPR. BY	JEB	DATE	6-1-06				
REVISION NO.	XXXX	REVISION DATE	MM/DD/YY	APPR. BY	XXXX	APPR. DATE	MM/DD/YY				

Rev. No.	Revision Date	Drawn By	Description of Revision
0	6-1-06	DAS	<b>OPW Sills</b>

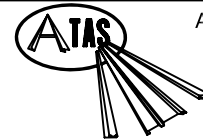
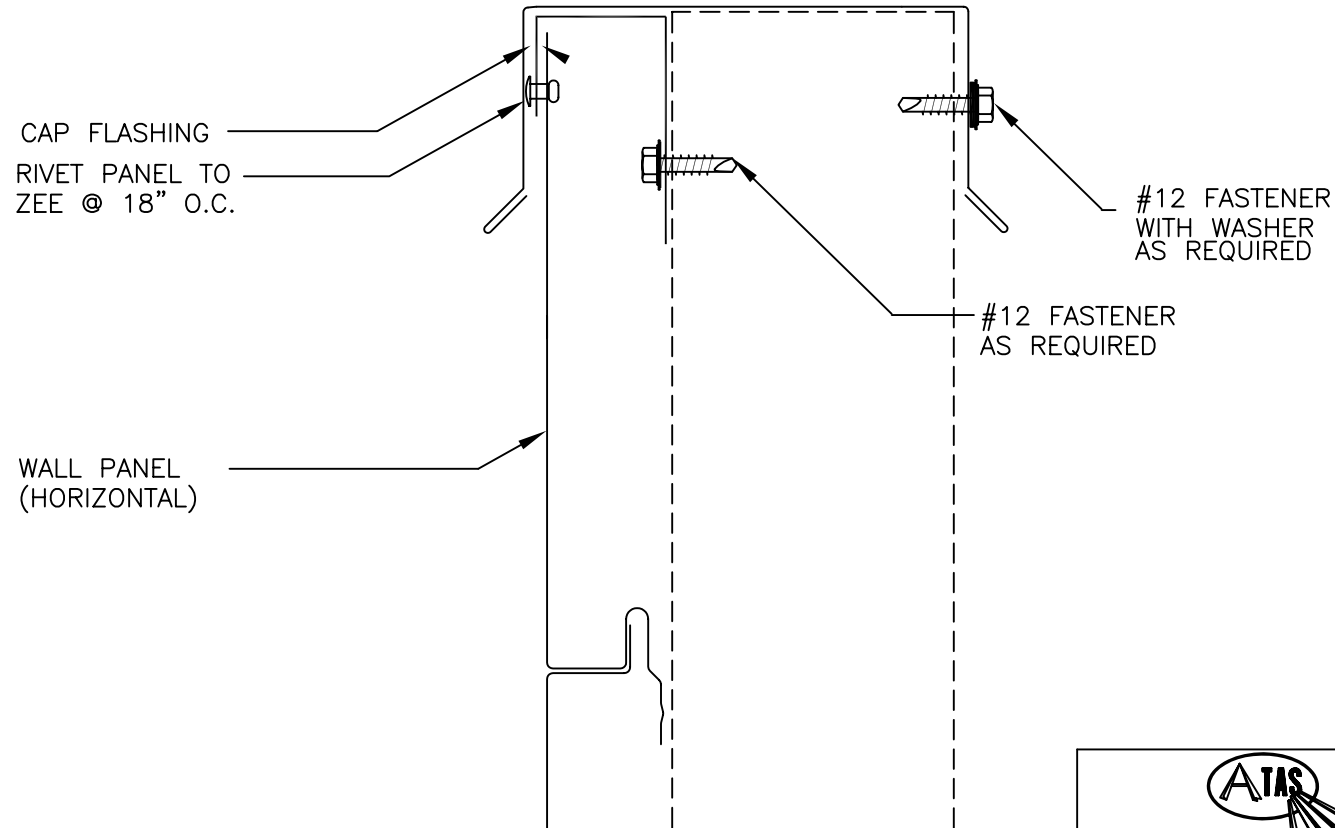

ATAS INTERNATIONAL, INC.  
 Allentown PA  
 610-395-8445  
 Mesa AZ  
 480-558-7210

TITLE		<b>OPW Cap Detail</b>					
DWG NO. / FILE NO.		<b>OPW Cap Detail</b>				SCALE	3"=1'-0"
DRAWN BY	DAS	DATE	3-6-06	APPR. BY	JEB	DATE	6-1-06
REVISION NO.	XXXX	REVISION DATE	MM/DD/YY	APPR. BY	XXXX	APPR. DATE	MM/DD/YY

Rev. No.	Revision Date	Drawn By	Description of Revision
0	6-1-06	DAS	<b>OPW Cap Detail</b>

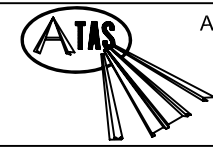
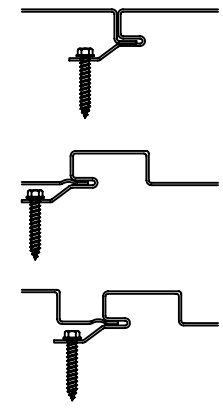
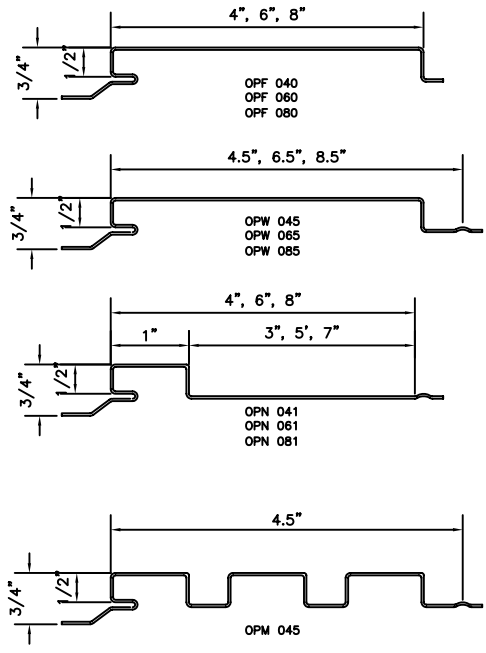

ATAS INTERNATIONAL, INC.  
Allentown PA  
610-395-8445  
Mesa AZ  
480-558-7210

TITLE		<b>OPALINE Profiles</b>					
DWG NO. / FILE NO.		<b>OPALINE Profiles</b>				SCALE	3"=1'-0"
DRAWN BY	DAS	DATE	3-6-06	APPR. BY	JEB	DATE	6-1-06
REVISION NO.	XXXX	REVISION DATE	MM/DD/YY	APPR. BY	XXXX	APPR. DATE	MM/DD/YY

Rev. No.	Revision Date	Drawn By	Description of Revision
0	6-1-06	DAS	<b>OPALINE Profiles</b>