

Snap on Ceiling Panel - Box Style

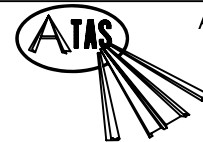

ATAS INTERNATIONAL, INC.  
 Allentown PA  
 610-395-8445  
 Mesa AZ  
 480-558-7210

TITLE		<b>Snap on Ceiling Panel - Box Style</b>					
DWG NO. / FILE NO.		<b>Snap on Ceiling Panel - Box Style</b>				SCALE	1"=1"
DRAWN BY	DAS	DATE	3-6-06	APPR. BY	JEB	DATE	6-1-06
REVISION NO.	XXXX	REVISION DATE	MM/DD/YY	APPR. BY	XXXX	APPR. DATE	MM/DD/YY

Rev. No.	Revision Date	Drawn By	Description of Revision
0	6-1-06	DAS	<b>Snap on Ceiling Panel - Box Style</b>

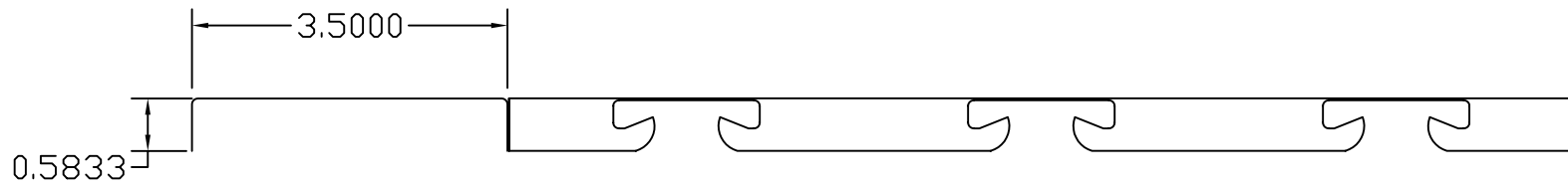

Suspended Box Carrier

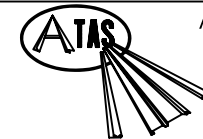

ATAS INTERNATIONAL, INC.  
 Allentown PA  
 610-395-8445  
 Mesa AZ  
 480-558-7210

TITLE		<b>Suspended Box Carrier</b>					
DWG NO. / FILE NO.		<b>Suspended Box Carrier</b>				SCALE	1"=1"
DRAWN BY	DAS	DATE	3-6-06	APPR. BY	JEB	DATE	6-1-06
REVISION NO.	XXXX	REVISION DATE	MM/DD/YY	APPR. BY	XXXX	APPR. DATE	MM/DD/YY

Rev. No.	Revision Date	Drawn By	Description of Revision
0	6-1-06	DAS	<b>Suspended Box Carrier</b>

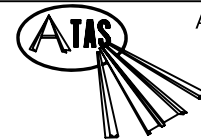
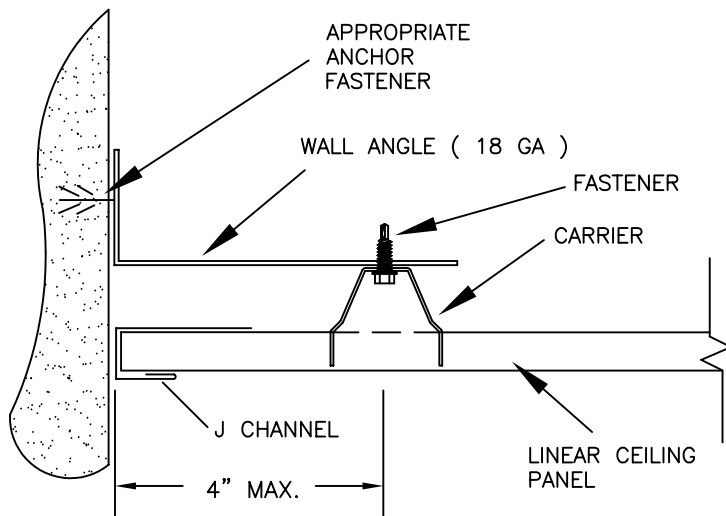

ATAS INTERNATIONAL, INC.  
 Allentown PA  
 610-395-8445  
 Mesa AZ  
 480-558-7210

TITLE **Linear Ceiling Edge Detail Rigid Support**

DWG NO. / FILE NO. **Linear Ceiling Edge Detail Rigid Support** SCALE 3"=1'-0"

DRAWN BY DAS DATE 3-6-06 APPR. BY JEB DATE 6-1-06

REVISION NO. XXXX REVISION DATE MM/DD/YY APPR. BY XXXX APPR. DATE MM/DD/YY

Rev. No.	Revision Date	Drawn By	Description of Revision
0	6-1-06	DAS	<b>Linear Ceiling Edge Detail Rigid Support</b>



Flush or Recessed  
Filler Strips

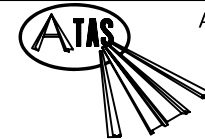

ATAS INTERNATIONAL, INC.  
Allentown PA  
610-395-8445  
Mesa AZ  
480-558-7210

TITLE		Flush or Recessed Filler Clips							
DWG NO. / FILE NO.		Flush or Recessed Filler Clips				SCALE		1"=1"	
DRAWN BY	DAS	DATE	3-6-06	APPR. BY	JEB	DATE	6-1-06		
REVISION NO.	XXXX	REVISION DATE	MM/DD/YY	APPR. BY	XXXX	APPR. DATE	MM/DD/YY		

Rev. No.	Revision Date	Drawn By	Description of Revision
0	6-1-06	DAS	Flush or Recessed Filler Clips

LINEAR CEILING - Flush Filler

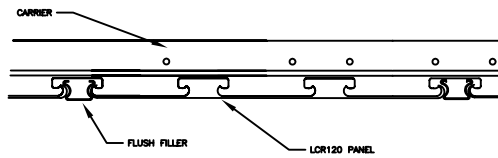

LINEAR CEILING - Recessed Filler

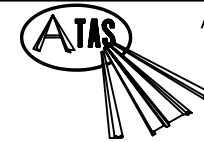
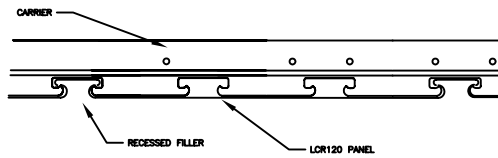

ATAS INTERNATIONAL, INC.  
 Allentown PA  
 610-395-8445  
 Mesa AZ  
 480-558-7210

TITLE		<b>Linear Ceiling Installation</b>					
DWG NO. / FILE NO.		<b>Linear Ceiling Installation</b>				SCALE	3"=1'-0"
DRAWN BY	DAS	DATE	3-6-06	APPR. BY	JEB	DATE	6-1-06
REVISION NO.	XXXX	REVISION DATE	MM/DD/YY	APPR. BY	XXXX	APPR. DATE	MM/DD/YY

Rev. No.	Revision Date	Drawn By	Description of Revision
0	6-1-06	DAS	<b>Linear Ceiling Installation</b>

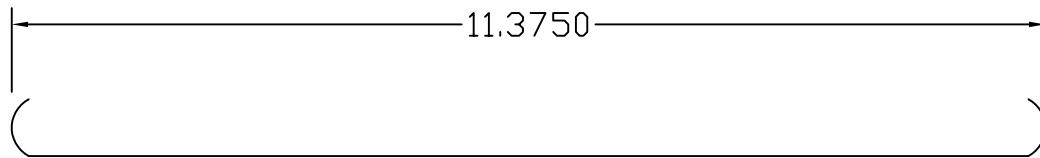
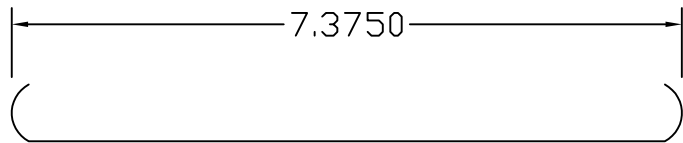
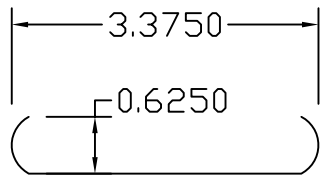

Snap on Ceiling Panel - Round Edge

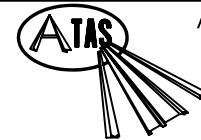

ATAS INTERNATIONAL, INC.  
 Allentown PA  
 610-395-8445  
 Mesa AZ  
 480-558-7210

TITLE		<b>Snap on Ceiling Panel - Round Edge</b>					
DWG NO. / FILE NO.		<b>Snap on Ceiling Panel - Round Edge</b>				SCALE	1"=1"
DRAWN BY	DAS	DATE	3-6-06	APPR. BY	JEB	DATE	6-1-06
REVISION NO.	XXXX	REVISION DATE	MM/DD/YY	APPR. BY	XXXX	APPR. DATE	MM/DD/YY

Rev. No.	Revision Date	Drawn By	Description of Revision
0	6-1-06	DAS	<b>Snap on Ceiling Panel - Round Edge</b>

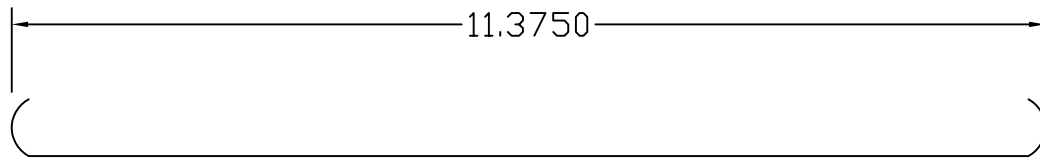
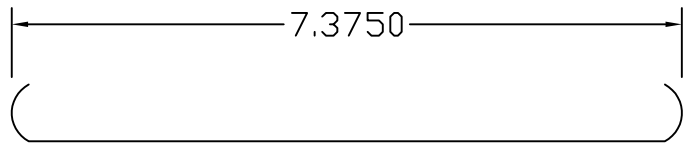
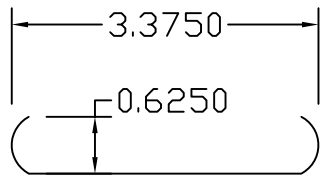

Snap on Ceiling Panel - Round Edge

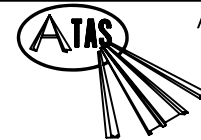

ATAS INTERNATIONAL, INC.  
 Allentown PA  
 610-395-8445  
 Mesa AZ  
 480-558-7210

TITLE		<b>Snap on Ceiling Panel - Round Edge</b>					
DWG NO. / FILE NO.		<b>Snap on Ceiling Panel - Round Edge</b>				SCALE	1"=1"
DRAWN BY	DAS	DATE	3-6-06	APPR. BY	JEB	DATE	6-1-06
REVISION NO.	XXXX	REVISION DATE	MM/DD/YY	APPR. BY	XXXX	APPR. DATE	MM/DD/YY

Rev. No.	Revision Date	Drawn By	Description of Revision
0	6-1-06	DAS	<b>Snap on Ceiling Panel - Round Edge</b>

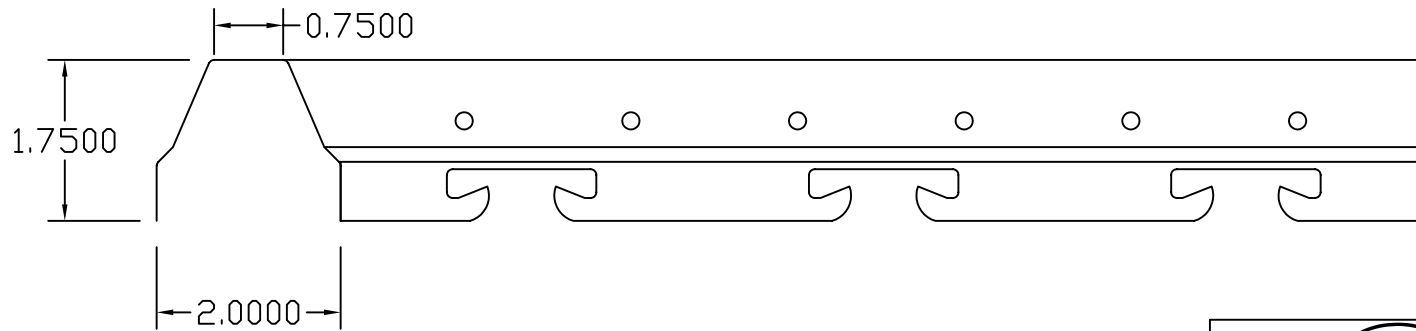

Suspended Carrier

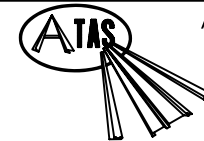

ATAS INTERNATIONAL, INC.  
 Allentown PA  
 610-395-8445  
 Mesa AZ  
 480-558-7210

TITLE		<b>Suspended Carrier</b>					
DWG NO. / FILE NO.		<b>Suspended Carrier</b>				SCALE	1"=1"
DRAWN BY	DAS	DATE	3-6-06	APPR. BY	JEB	DATE	6-1-06
REVISION NO.	XXXX	REVISION DATE	MM/DD/YY	APPR. BY	XXXX	APPR. DATE	MM/DD/YY

Rev. No.	Revision Date	Drawn By	Description of Revision
0	6-1-06	DAS	<b>Suspended Carrier</b>

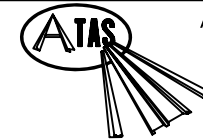
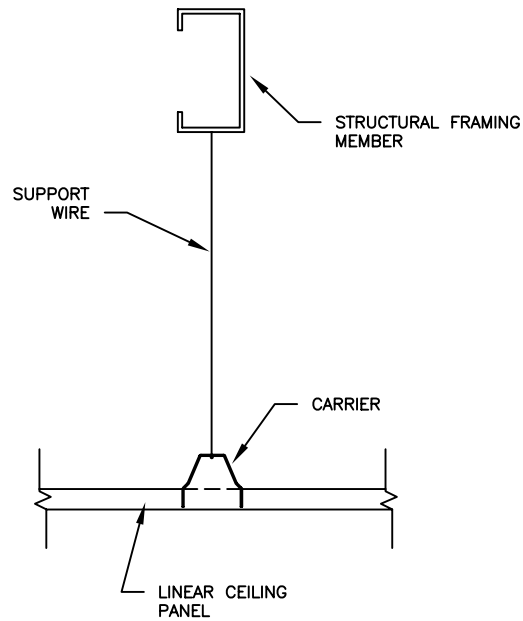

ATAS INTERNATIONAL, INC.  
 Allentown PA  
 610-395-8445  
 Mesa AZ  
 480-558-7210

TITLE		<b>Linear Ceiling Threaded Rod</b>					
DWG NO. / FILE NO.		<b>Linear Ceiling Threaded Rod</b>				SCALE	3"=1'-0"
DRAWN BY	DAS	DATE	3-6-06	APPR. BY	JEB	DATE	6-1-06
REVISION NO.	XXXX	REVISION DATE	MM/DD/YY	APPR. BY	XXXX	APPR. DATE	MM/DD/YY

Rev. No.	Revision Date	Drawn By	Description of Revision
0	6-1-06	DAS	<b>Linear Ceiling Threaded Rod</b>