

PCA910 "Z" Closure
To be used with PC systems using either PCS114 or PCB001 seam covers.

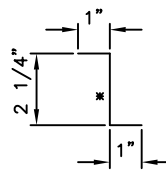

PCA912 "Z" Closure

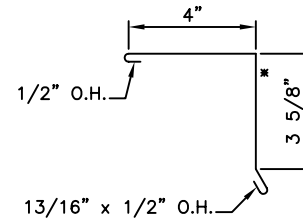

PCA210 Gable/Rake Closure Trim
To be used with PC systems using either PCS114 or PCB001 seam covers.

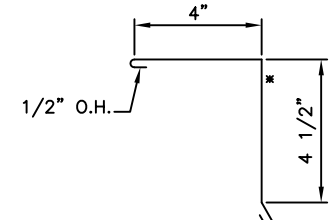

PCA212 Gable/Rake Closure Trim

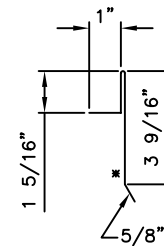

This part made only in .032 aluminum or 24 ga. steel.

PCA211 Gable/Rake Starter Cleat

This part will be hidden, therefore it will be furnished in any color.
To be used with PC systems using either PCS114 or PCB001 seam covers.

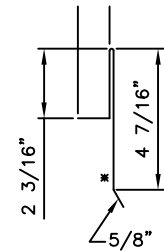

This part made only in .032 aluminum or 24 ga. steel.

PCA213 Gable/Rake Starter Cleat

This part will be hidden, therefore it will be furnished in any color.

To be used with the PC systems utilizing PCB002 seam covers only.

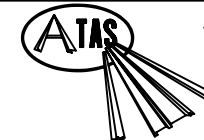
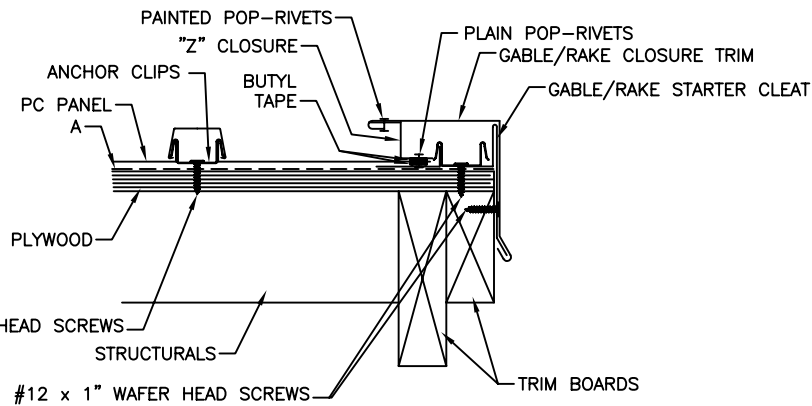

ATAS INTERNATIONAL, INC.
Allentown PA
610-395-8445
Mesa AZ
480-558-7210

TITLE		PC Panel Ending Gable - ply					
DWG NO. / FILE NO.		PC Panel Ending Gable - ply				SCALE	3"=1'-0"
DRAWN BY	DAS	DATE	3-6-06	APPR. BY	JEB	DATE	6-2-06
REVISION NO.	XXXX	REVISION DATE	MM/DD/YY	APPR. BY	XXXX	APPR. DATE	MM/DD/YY

Rev. No.	Revision Date	Drawn By	Description of Revision
0	6-2-06	DAS	PC Panel Ending Gable - ply