

ATAS INTERNATIONAL, INC.  
Allentown PA  
610-395-8445  
Mesa AZ  
480-558-7210

TITLE		<b>OPALINE Profiles</b>					
DWG NO. / FILE NO.		<b>OPALINE Profiles</b>				SCALE	3"=1'-0"
DRAWN BY	DAS	DATE	3-6-06	APPR. BY	JEB	DATE	6-1-06
REVISION NO.	XXXX	REVISION DATE	MM/DD/YY	APPR. BY	XXXX	APPR. DATE	MM/DD/YY

Rev. No.	Revision Date	Drawn By	Description of Revision
0	6-1-06	DAS	<b>OPALINE Profiles</b>

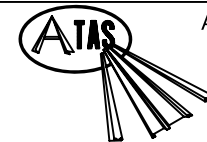
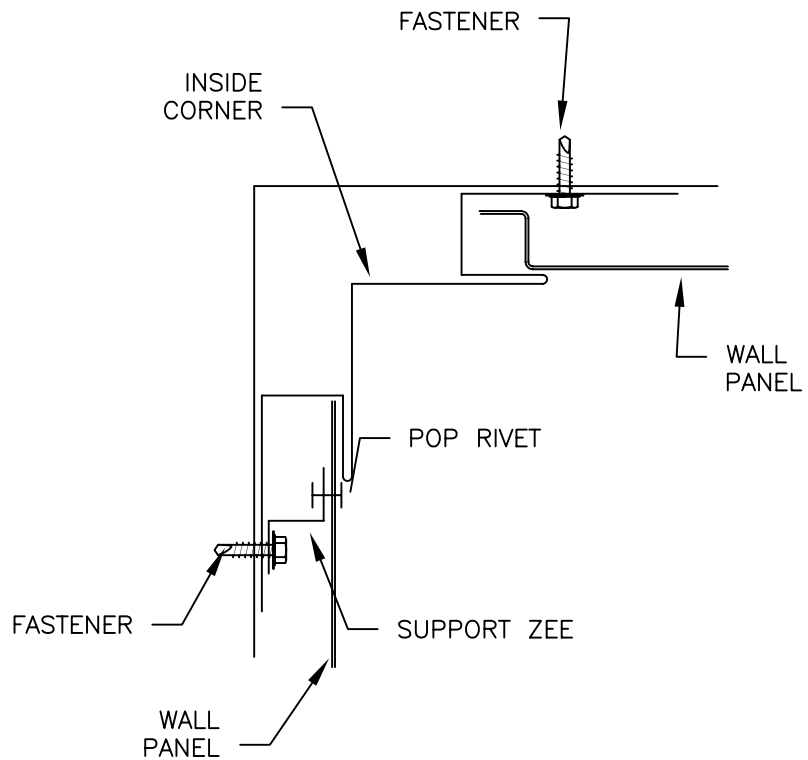

ATAS INTERNATIONAL, INC.  
 Allentown PA  
 610-395-8445  
 Mesa AZ  
 480-558-7210

TITLE		OPW Inside Corner					
DWG NO. / FILE NO.		OPW Inside Corner				SCALE	3"=1'-0"
DRAWN BY	DAS	DATE	3-6-06	APPR. BY	JEB	DATE	6-1-06
REVISION NO.	XXXX	REVISION DATE	MM/DD/YY	APPR. BY	XXXX	APPR. DATE	MM/DD/YY

Rev. No.	Revision Date	Drawn By	Description of Revision
0	6-1-06	DAS	OPW Inside Corner

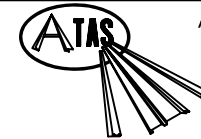
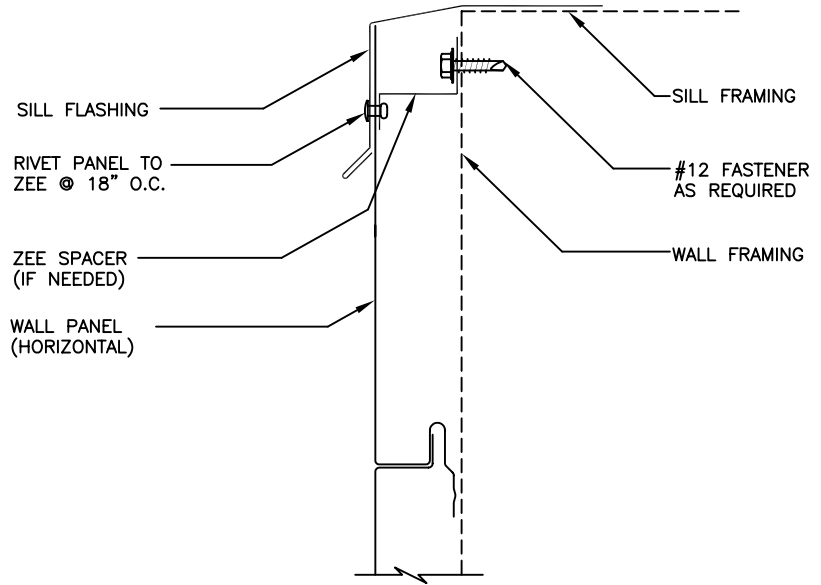
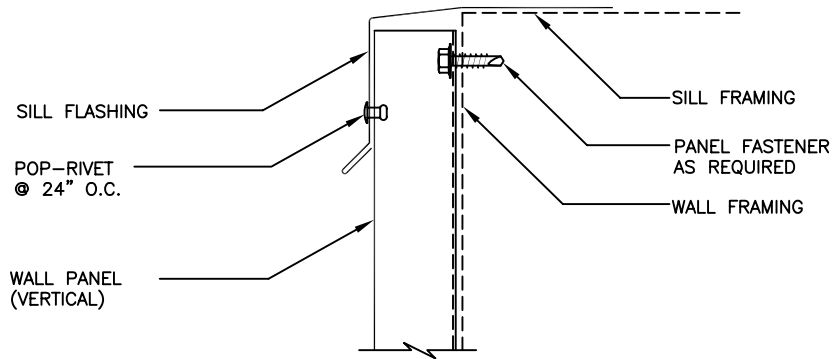

ATAS INTERNATIONAL, INC.  
Allentown PA  
610-395-8445  
Mesa AZ  
480-558-7210

TITLE

**OPW Sills**

DWG NO. /  
FILE NO.

**OPW Sills**

SCALE 3"=1'-0"

DRAWN  
BY

DAS

DATE

3-6-06

APPR.  
BY

JEB

DATE

6-1-06

REVISION  
NO.

XXXX

REVISION  
DATE

MM/DD/YY

APPR.  
BY

XXXX

APPR.  
DATE

MM/DD/YY

Rev.  
No.

Revision Date

Drawn  
By

DAS

Description of Revision

**OPW Sills**

0

6-1-06

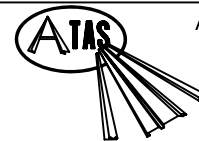
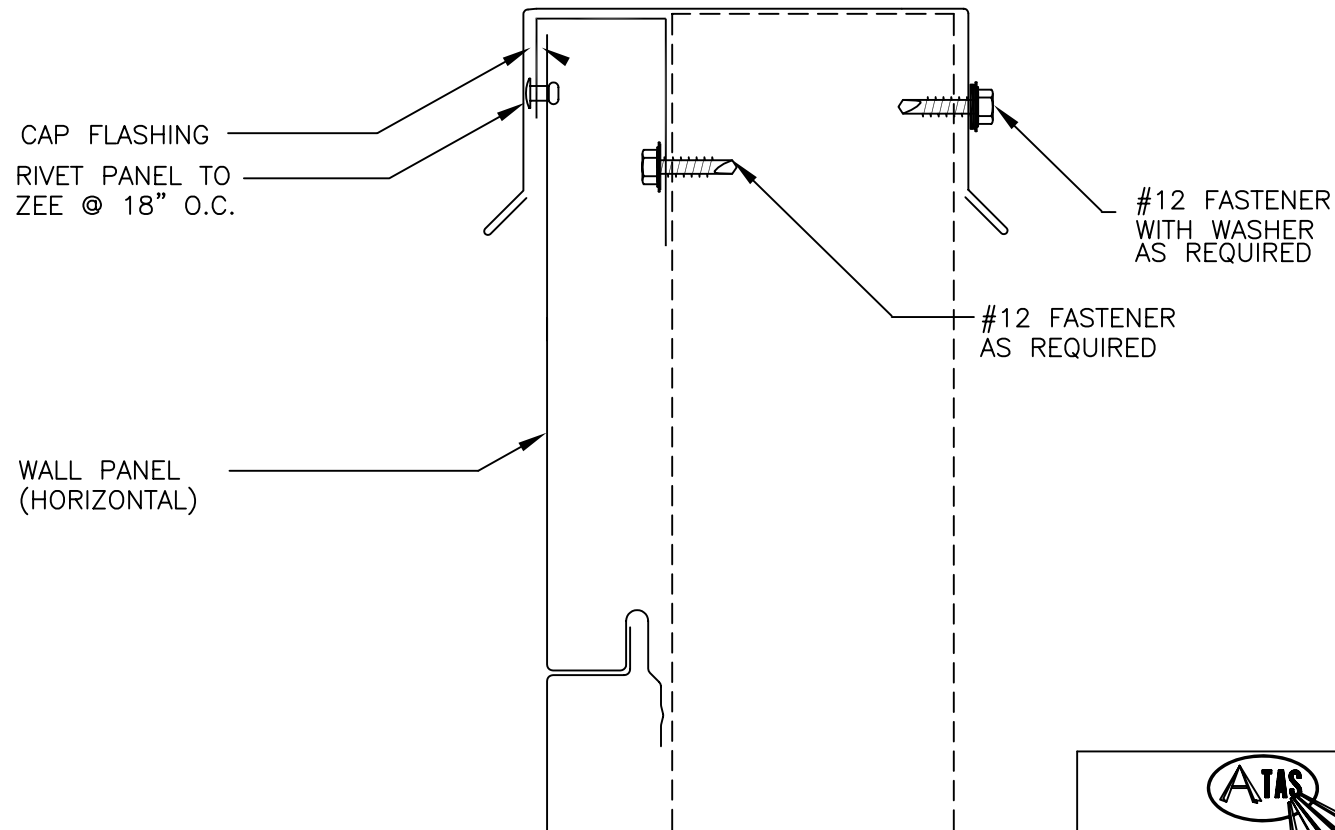

ATAS INTERNATIONAL, INC.  
 Allentown PA  
 610-395-8445  
 Mesa AZ  
 480-558-7210

TITLE		<b>OPW Cap Detail</b>					
DWG NO. / FILE NO.		<b>OPW Cap Detail</b>				SCALE	3"=1'-0"
DRAWN BY	DAS	DATE	3-6-06	APPR. BY	JEB	DATE	6-1-06
REVISION NO.	XXXX	REVISION DATE	MM/DD/YY	APPR. BY	XXXX	APPR. DATE	MM/DD/YY

Rev. No.	Revision Date	Drawn By	Description of Revision
0	6-1-06	DAS	<b>OPW Cap Detail</b>

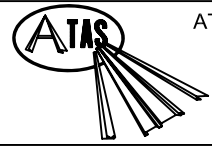
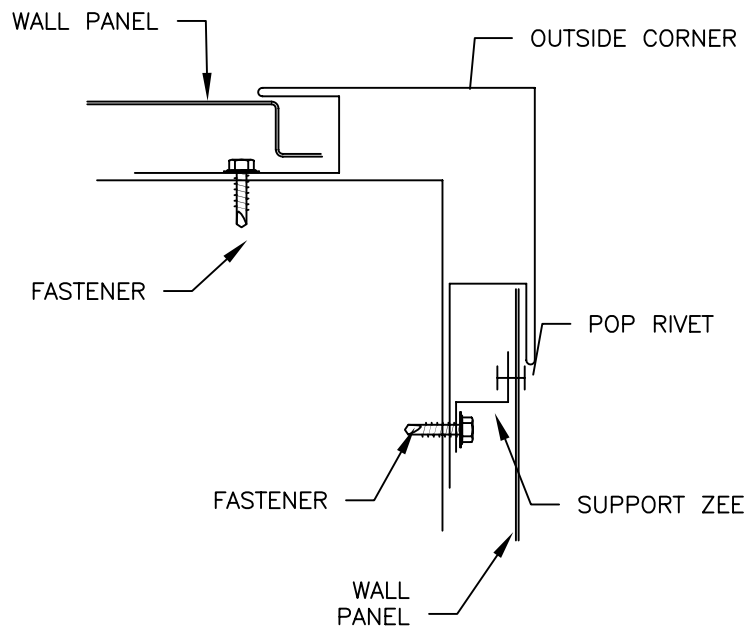

ATAS INTERNATIONAL, INC.  
 Allentown PA  
 610-395-8445  
 Mesa AZ  
 480-558-7210

TITLE		<b>OPW Outside Corner</b>					
DWG NO. / FILE NO.		<b>OPW Outside Corner</b>				SCALE	3"=1'-0"
DRAWN BY	DAS	DATE	3-6-06	APPR. BY	JEB	DATE	6-1-06
REVISION NO.	XXXX	REVISION DATE	MM/DD/YY	APPR. BY	XXXX	APPR. DATE	MM/DD/YY

Rev. No.	Revision Date	Drawn By	Description of Revision
0	6-1-06	DAS	<b>OPW Outside Corner</b>